



X1 Series User Manual

2.5kW - 6.0kW



Solax Power Network Technology (Zhejiang) Co., Ltd.

No.288 Shizhu Road, Tonglu Economic Development Zone,
Tonglu City, Zhejiang province, China.

Tel: +86 0571-56260011

E-mail: info@solaxpower.com

EN

Copyright Declaration

The copyright of this manual belongs to Solax Power Network Technology (Zhejiang) Co., Ltd. Any corporation or individual should not plagiarize, partially or fully copy (including software, etc.), and no replication or distribution of it in any form or by any means. All rights reserved. Solax Power Network Technology (Zhejiang) Co., Ltd. reserves the right of final interpretation.

CHANGE HISTORY

Changes between document versions are cumulative. The latest version contains all updates made in previous versions.

Version 01 (Jan. 03, 2023)

Updated 4. Technical Data (Added technical data).

Version 00 (Sept. 27, 2022)

Initial release

Contents

1	Note on this Manual	03
1.1	Scope of Validity	03
1.2	Target Group	03
1.3	Symbols Used	03
2	Safety	04
2.1	Appropriate Usage	04
2.2	Important Safety Instructions	06
2.3	Explanation of Symbols	10
2.4	EC Directives	11
3	Introduction	12
3.1	Basic Features.....	12
3.2	Terminals of the Inverter	12
3.3	Dimension	13
4	Technical Data	14
4.1	DC Input	14
4.2	AC Output	14
4.3	Efficiency, Safety and Protection	15
4.4	System Data	15
5	Installation	16
5.1	Check for Transport Damage	16
5.2	Packing Lists.....	16
5.3	Installation Precaution	17
5.4	Installation Steps	18
5.5	Connections of the Inverter	22
5.6	Run the Inverter	46
5.7	Isolation Fault Alarm	47
6	Operation Method	48
6.1	Control Panel	48
6.2	LCD Structure	49

6.3 LCD Operation 50

7 Troubleshooting 76

7.1 Troubleshooting 76

7.2 Routine Maintenance 79

8 Decommissioning 80

8.1 Dismantling the Inverter 80

8.2 Packaging 80

8.3 Storage and Transportation 80

8.4 Disposal of the inverter 80

9 Disclaimer 81

* Warranty registration form

1 Notes on this Manual

1.1 Scope of Validity

This manual is an integral part of X1 Series. It describes the assembly, installation, commissioning, maintenance and failure of the product. Please read it carefully before operating.

X1-BOOST-2.5K-G4	X1-BOOST-3K-G4	X1-BOOST-3.3K-G4
X1-BOOST-3.6K-G4	X1-BOOST-4.2K-G4	X1-BOOST-5K-G4
X1-BOOST-6K-G4		





Note: "X1" : single phase; "BOOST": BOOST series; "3K": 3kW; "G4": the 4th generation
 Keep this manual at where is accessible all the time.

1.2 Target Group

This manual is for qualified electricians. The tasks described in this manual can only be performed by qualified electricians.

1.3 Symbols Used

The following types of safety instructions and general information appear in this document are shown as below:

	DANGER! "Danger" indicates a hazardous situation which, if not avoided, will result in death or serious injury.
	WARNING! "Warning" indicates a hazardous situation which, if not avoided, could result in death or serious injury.
	CAUTION! "Caution" indicates a hazardous situation which, if not avoided, could result in death or serious injury.
	NOTE! "Note" provides tips that are valuable for the optimal operation of your product.

2 Safety

2.1 Appropriate Usage

The X1 Series are PV inverters which can convert the DC current of the PV generator into AC current and feed it into the public grid.

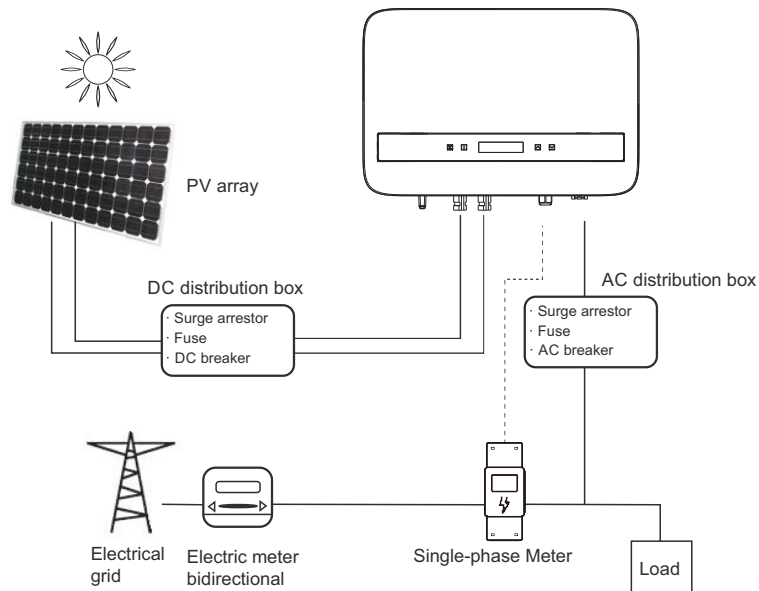

WARNING !
Potential surge shock may damage the inverter.

Lightning will cause a damage either from a direct strike or from surges due to a nearby strike.

Induced surges are the most likely cause of lightning damage in majority situations or installations, especially in rural areas where electricity is usually provided by long overhead lines. Surge may be included on both the PV array conduction and the AC cables leading to the building.

Consultation by specialists in lightning protection is required during the end use application. Using appropriate external lightning protection, the effect of a direct lightning strike into a building can be mitigated in a controlled way, and the lightning current can be discharged into the ground.

All DC cables should be installed as short as possible, and positive and negative cables of the string or main DC supply should be bundled together. Avoid creating loops in the system. This requirement for short runs and bundling includes any associated earth bundling conductors.

Spark gap devices are not suitable to be used in DC circuits once conducting, they won't stop conducting until the voltage passes through their terminals typically less than 30 volts.

➤ Anti-Islanding Effect

Islanding effect is a special phenomenon that the grid-connected PV system still supply power to the nearby grid when electrical grid power is no longer present. It is dangerous for maintenance personnel and the public. X1 series provide Active Frequency Drift (AFD) to prevent the islanding effect.

2.2 Important Safety Instructions



DANGER!

Danger to life due to high voltages in the inverter!

- All work must be carried out by qualified electrician.
- The appliance should not be used by children or persons with reduced physical sensory or mental capabilities, or lack of experience and knowledge, unless they have been given supervision or instruction.
- Children should be supervised to ensure that they do not play with the appliance.



CAUTION!

Danger of burn injuries due to hot enclosure parts!

- During operation, the upper lid of the enclosure and the enclosure body may become hot.



CAUTION!

Possible damage to health as a result of the effects of radiation!

- Pregnant women and kids should not stay close to the inverter.



NOTE!

Grounding the PV generator.

- Comply with the local requirements for grounding the PV modules and the PV generator. We recommend connecting the generator frame and other electrically conductive surfaces in a manner which ensures continuous conduction and grounding these in order to produce optimal protection of system and persons.



WARNING!

- Ensure input DC voltage \leq Max. DC voltage. Over voltage may cause permanent damage to inverter or other losses, which will not be included in warranty!



WARNING!

- Authorized service personnel must disconnect both AC and DC power from X1 series before attempting any maintenance or cleaning or working on any circuits connected to the X1 series.



WARNING!

Risk of electric shock!

- Prior to the application, please read this section carefully to ensure correct and safe application. Please keep the user manual properly.
- Only use attachments recommended or sold by us. Otherwise it may result in a risk of fire, electric shock, or injury to person.
- Make sure that the existing wiring is in good condition and that the wire is not undersized.
- Do not disassemble any parts of inverter which are not mentioned in installation guide. It contains no user-serviceable parts. See Warranty for instructions on obtaining service. Attempting to service the X1 Series inverter by yourself may result in a risk of electric shock or fire and will void your warranty. Keep away from flammable, explosive materials to avoid fire disaster. The installation place should be away from humid or corrosive substance. Authorized service personnel must use insulated tools when installing or working with this equipment.

- PV modules shall have an IEC 61730 class A rating.
- Avoid touching the PV connecting device in case of electric shock.
- After the MAINS and PV supply has been disconnected, the capacitor of the unit still contains hazardous voltage for up to 5 minutes, please don't touch during this period.



WARNING!
Hazardous voltage will present for up to 5 minutes after disconnection from power supply.

- CAUTION-RISK of electric shock from energy stored in capacitor. Never operate the solar inverter couplers, the MAINS cables, PV cables or the PV generator when power is applied. After switching off the PV and Mains, always wait for 5 minutes to let the intermediate circuit capacitors discharge before you unplug DC and MAINS couplers.
- When accessing the internal circuit of solar inverter, it is very important to wait 5 minutes before operating the power circuit or demounting the electrolyte capacitors inside the device. Do not open the device beforehand since the capacitors require time to sufficiently discharge!
- Measure the voltage between terminals UDC+ and UDC- with a multi-meter (impedance at least 1Mohm) to ensure that the device has totally discharged.
- The inverter incorporates a certified internal Residual Current Monitoring (RCM) in order to protect against possible electrocution and fire hazard in case of a malfunction in the cables or the inverter. There are two trip thresholds for the RCD as required for certification (IEC 62109-2: 2011). The default value for eletrocution protection is 30 mA, and for slow rising current is 300 mA.
- If an external RCD is required by local regulations, check which type of RCD is required for relevant electric code. It recommends using a type-A RCD. The recommended RCD values is 300mA unless a lower value is required by the specific local electric codes.

PE Connection and Leakage Current



WARNING !

- High leakage current!
- Earth connection essential before connecting supply.

- Incorrect grounding can cause physical injury, death or equipment malfunction and increase electromagnetic.
- Make sure that grounding conductor is adequately sized as required by safety regulations.

For United Kingdom

- The installation that connects the equipment to the supply terminals shall comply with the requirements of BS 7671.
- Electrical installation of PV system shall comply with requirements of BS 7671 and IEC 60364-7-712.
- No protection settings can be altered.
- Installer shall ensure that equipment is installed and operated by this means to comply with the requirements of ESQCR22(1)(a) at all times.



For Australia and New Zealand

- Electrical installation and maintenance shall be conducted by licensed electrician and shall comply with Australia National Wiring Rules.











2.3 Explanation of Symbols

This section gives an explanation of all the symbols shown on the inverter and on the type label.

• Symbols on the Inverter

Symbol	Explanation
	The inverter is working normally, when the blue light is on.
	An error has occurred, when the red light is on.

• Symbols on the Type Label

Symbol	Explanation
	CE mark. The inverter complies with the requirements of the applicable CE guidelines.
	Compliant with UKCA standards.
	RCM remark.
	TUV certification.
	Beware of hot surface. The inverter can become hot during operation. Avoid contact during operation.
	Danger of high voltages. Danger to life due to high voltages in the inverter!
	Danger. Risk of electric shock!
	Observe enclosed documentation.
	The inverter can not be disposed together with the household waste. Disposal information can be found in the enclosed documentation.
	Do not operate this inverter until it is isolated from mains and on-site PV generation suppliers.
	Danger to life due to high voltage. There is residual voltage in the inverter which needs 5 min to discharge. • Wait 5 min before you open the upper lid or the DC lid.

2.4 EC Directives

This section describes the requirements of the European low voltage regulations, including safety instructions and system licensing conditions, the user must comply with these regulations when installing, operating, and maintaining the inverter, otherwise personal injury or death may occur, and the inverter will be damaged. Please read the manual carefully when operating the inverter. If you do not understand "Danger", "Warning", "Caution" and the description in the manual, please contact the manufacturer or service agent before installing and operating the inverter.

Make sure that the whole system complies with the requirements of EC (2014/35/EU, 2014/30/EU, etc.) before starting the module (i.e. to start the operation).

Standard of 2014/35/EU (LVD)
EN IEC 62109-1; EN IEC 62109-2
EN 62477-1
Standard of 2014/30/EU (EMC)
EN IEC 61000-6-1; EN IEC 61000-6-2;
EN IEC 61000-6-3; EN IEC 61000-6-4;
EN IEC 61000-3-2; EN 61000-3-3;
EN IEC 61000-3-11; EN 61000-3-12
EN 55011

The assembly shall be installed in accordance with the statutory wiring rules. Install and configure the system in accordance with safety rules, including the use of specified wiring methods. The installation of the system can only be done by professional assemblers who are familiar with safety requirements and EMC. The assembler shall ensure that the system complies with the relevant national laws. The individual subassembly of the system shall be interconnected by means of the wiring methods outlined in national/international such as the national electric code (NFPA) No. 70 or VDE regulation 4105.

3. Introduction

3.1 Basic Features

Thanks for purchasing our inverter. The inverter incorporates advanced technology, high reliability, and convenient control features.

- Advanced DSP control technology.
- Utilize the latest high-efficiency power component.
- Optimal MPPT technology.
- Two independent MPP Tracking.
- Wide MPPT input range.
- Advanced anti-islanding solutions.
- IP66 protection level.
- Max. efficiency up to 98%. EU efficiency up to 97%.
- THD<2%.

3.2 Terminals of the Inverter

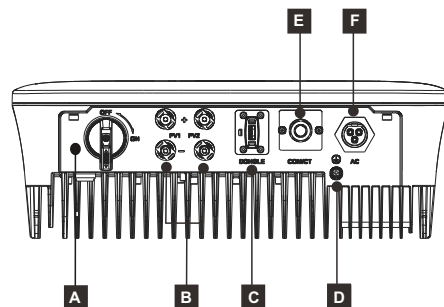

Object	Description
A	DC Switch (optional)
B	DC Connector
C	DONGLE
D	Ground screw
E	RS485/ Meter/ CT/ DRM(optional)
F	AC Connector

Note: Wi-Fi/ LAN/ 4G DONGLE shares one port C; RS485/ Meter/ DRM shares one port E.

Whether DC Switch is equipped with lock depends on local requirements. DC Switch may vary slightly because it has two versions: Australia version (as shown above) and general version.



WARNING!

Only authorized personnel are allowed to connect.

3.3 Dimension

➤ Dimension

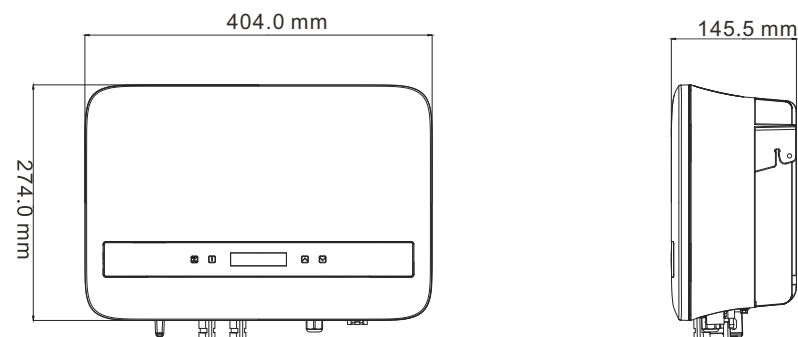

4. Technical Data

4.1 DC Input

Model	X1-BOOST-2.5K-G4	X1-BOOST-3K-G4	X1-BOOST-3.3K-G4	X1-BOOST-3.6K-G4	X1-BOOST-4.2K-G4	X1-BOOST-5K-G4	X1-BOOST-6K-G4
Max. PV array input power [Wp]	6000	6000	6600	7200	8000	10000	12000
Max. PV voltage [d.c.V]	600	600	600	600	600	600	600
Startup voltage [d.c.V]	50	50	50	50	50	50	50
Nominal input voltage [d.c.V]	360	360	360	360	360	360	360
MPPT voltage range [d.c.V]	40-560	40-560	40-560	40-560	40-560	40-560	40-560
No. of MPP trackers/Strings per MPP tracker	2/1						
Max. PV current(input A/input B) [d.c.A]	16/16						
I _{sc} PV array Short Circuit Current(input A/input B) [d.c.A]	22/22						
Max. inverter backfeed current to the array [d.c.A]	0						

4.2 AC Output

Model	X1-BOOST-2.5K-G4	X1-BOOST-3K-G4	X1-BOOST-3.3K-G4	X1-BOOST-3.6K-G4	X1-BOOST-4.2K-G4	X1-BOOST-5K-G4	X1-BOOST-6K-G4
Rated Output Apparent Power [VA]	2500	3000	3300	3680	4200	5000 ³	6000
Rated output current [a.c.A]	10.9	13.1	14.4	16	18.3	21.7 ⁴	26.1
Max. output apparent power [VA]	2750	3300	3630	4048 ¹	4620	5000 ⁵	6000
Max. Output Continuous Current [a.c.A]	12	14.4	15.8	17.6 ²	20.1	21.7 ⁶	27.3
Grid voltage [V]/Grid range	220/230/240; 90-290						
Nominal grid frequency/Grid frequency range [Hz]	50/60; ±5						
Power factor range	0.8leading-0.8lagging						
THDi (rated power) [%]	<3						
Nominal AC Voltage [a.c.V]	220/230/240						
Current (inrush) [a.c. A]	13.5						
Maximum output fault current [a.c.A]	59 (3 ms)						
Maximum output overcurrent protection [a.c.A]	50						

Note:

1. 4048 (3680 For G98, TOR and PPDS)
2. 17.6 (16 For G98, TOR and PPDS)
3. 5000 (4600 for VDE4105);
4. 21.7 (20 for VDE4105).
5. 5000 (4600 for VDE4105);
6. 21.7 (20 for VDE4105).

4.3 Protection

Model	X1-BOOST-2.5K-G4	X1-BOOST-3K-G4	X1-BOOST-3.3K-G4	X1-BOOST-3.6K-G4	X1-BOOST-4.2K-G4	X1-BOOST-5K-G4	X1-BOOST-6K-G4
Safety & Protection							
Over/under voltage protection	YES						
DC isolation protection	YES						
Monitoring ground fault protection	YES						
Grid protection	YES						
DC injection monitoring	YES						
Back feed current monitoring	YES						
Residual current detection	YES						
Anti-islanding protection	YES						
Over temperature protection	YES						
SPD (DC/AC)	II/III						
AFCI (Arc-Fault Circuit-Interrupter)	Optional						
Standard							
Safety	EN/IEC62109-1/2						
EMC	EN61000-6-1/2/3/4; EN61000-3-2/3/11/12;EN55011						
Grid monitoring	IEC61727, EN50549, G98/G99, AS 4777.2, VDE4105, CEI 0-21, VFR, PPDS, TOR						

4.4 System data

Model	X1-BOOST-2.5K-G4	X1-BOOST-3K-G4	X1-BOOST-3.3K-G4	X1-BOOST-3.6K-G4	X1-BOOST-4.2K-G4	X1-BOOST-5K-G4	X1-BOOST-6K-G4
System data							
Max. efficiency [%]	98	98	98	98	98	98	98
Euro. efficiency [%]	97	97	97	97	97	97	97
Standby consumption [W] @Night	3						
Ingress protection	IP66						
Operating Ambient Temperature Range [°C]	-25~60						
Max. operation altitude [m]	4000						
Humidity [%]	0~100						
Typical noise emission [dB]	25 ¹						
Storage temperature [°C]	-30~70						
Dimensions(W×H×D) [mm]	404x274x146						
Weight [kg]	11.5	11.5	11.5	11.5	11.5	11.5	11.5
Cooling concept	Nature cooling						
Communication interfaces	RS485/DRM/USB/Heat Pump, Optional: CT/Meter;						
Optional monitoring dongle	Pocket WiFi/LAN/4G						
Protective class	I						

Note:

1. For models with internal fan (optional), typical noise emission is 30 dB.

Model	X1-BOOST-2.5K-G4	X1-BOOST-3K-G4	X1-BOOST-3.3K-G4	X1-BOOST-3.6K-G4	X1-BOOST-4.2K-G4	X1-BOOST-5K-G4	X1-BOOST-6K-G4
System data							
Overvoltage Category	III (MAINS), II (DC)						
Inverter Topology	Non-isolated						
Active anti-islanding method	Frequency Shift						

5. Installation

5.1 Check for Transport Damage

Make sure the inverter is intact during transportation. If there are some visible damages, such as cracks, please contact your dealer immediately.

5.2 Packing Lists

Open the package and fetch out the product, check the accessories at first. The packing list is shown as below.

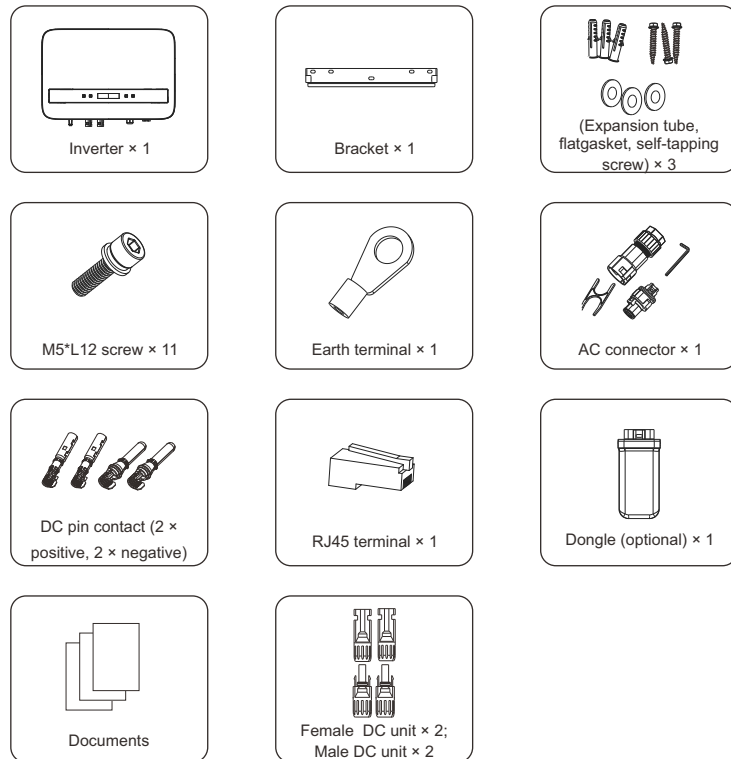

NOTE!
For the optional accessories, please be subject to the actual delivery.

5.3 Installation Precaution

X1 Series inverter is designed for outdoor installation (IP 66).

Make sure the installation site meets the following conditions:

- Avoid exposure to glare.
- Avoid placing in areas where highly flammable materials are stored.
- Avoid placing in potential explosive areas.
- Avoid placing near the television antenna or antenna cable.
- Avoid placing in an altitude of higher than 4000 m above sea level.
- Be sure the ventilation is good enough.
- The ambient temperature and relative humidity must meet the following requirements respectively: +60°C~25°C; 0~100%.
- The slope of the wall should be within ±5°.

The wall hanging the inverter should meet conditions below:

- Solid brick/concrete, or strength equivalent mounting surface;
- Inverter must be supported or strengthened if the wall's strength isn't enough (Such as wooden wall, the wall covered by thick layer of decoration).

Please avoid direct sunlight, rain exposure, snow laying up during installing and operating.

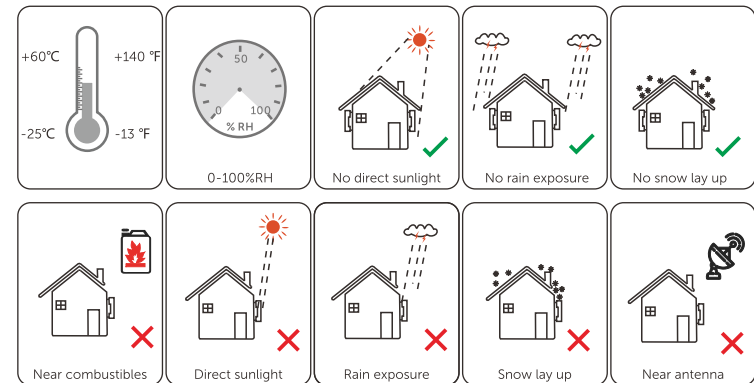

Inverter can be installed inside an enclosure, make sure it meets the above requirements, the following space size requirements and enough ventilation.

Available Space Size

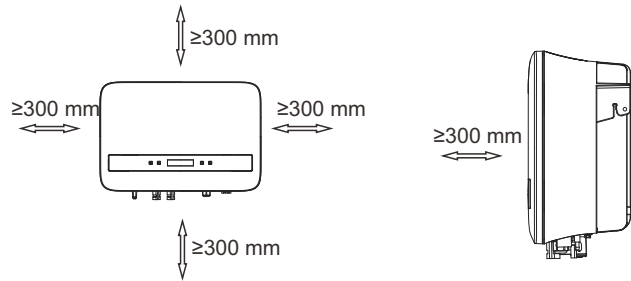

Table Available Space Size

Position	Min.size
Left	300 mm
Right	300 mm
Top	300 mm
Bottom	300 mm
Front	300 mm



NOTE!

Avoid installing in the confined space.

5.4 Installation Steps

➤ Preparation

Tools below are needed before installation.

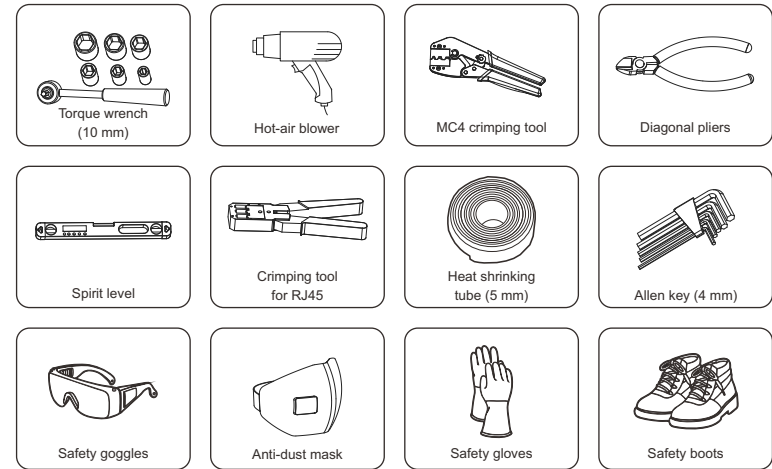
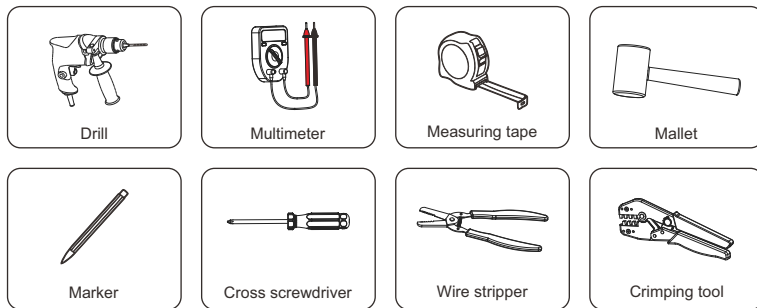

- Step 1: Screw the wall bracket on the wall
- a) Use the wall bracket as a template to mark the position of the 3 holes on the wall using a marker, and adjust it even using the spirit level.

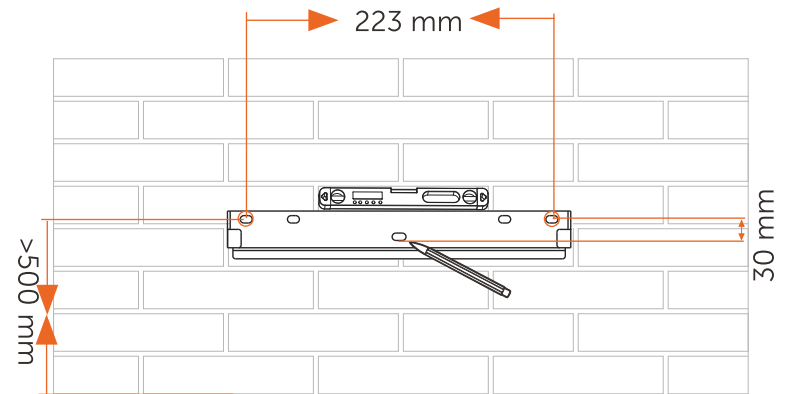

b) Drill holes with a drill (drill bit: 10 mm), make sure the holes are deep enough (at least 60 mm) for installation.

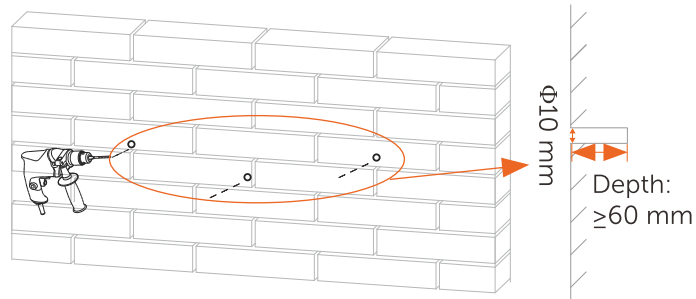

c) Insert the expansion tubes in the holes, place the wall bracket and use self-tapping screws to tighten the bracket.

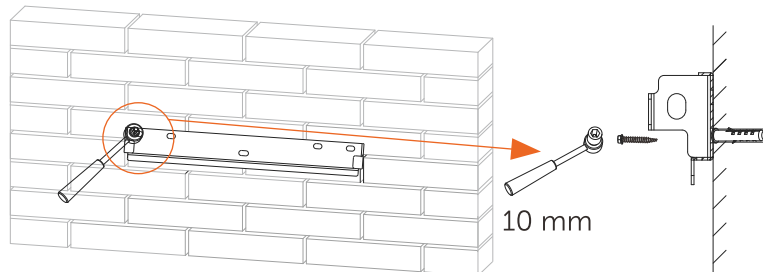
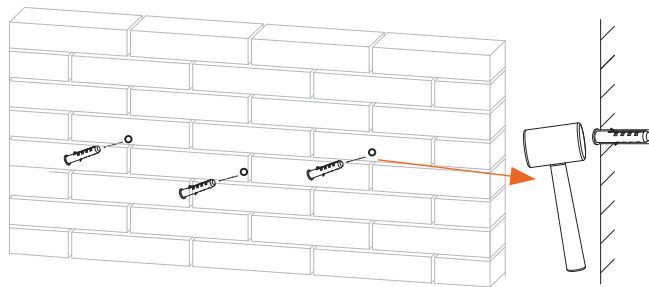

➤ Step 2: Match the inverter with the wall bracket
 d) Hang the inverter over the bracket, move the inverter close to it, slightly lay down the inverter, and make sure the 2 mounting bars on the back are fixed well with the 2 grooves on the bracket.

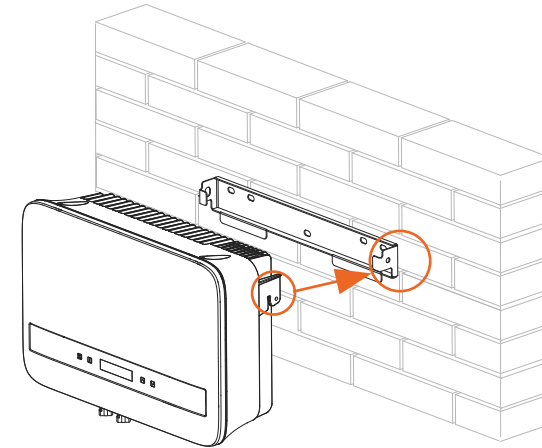

➤ Step 3: Fix the inverter with the wall bracket
 e) Fix the right hole of the inverter by using the hexagon socket head cap screw M5*L12.

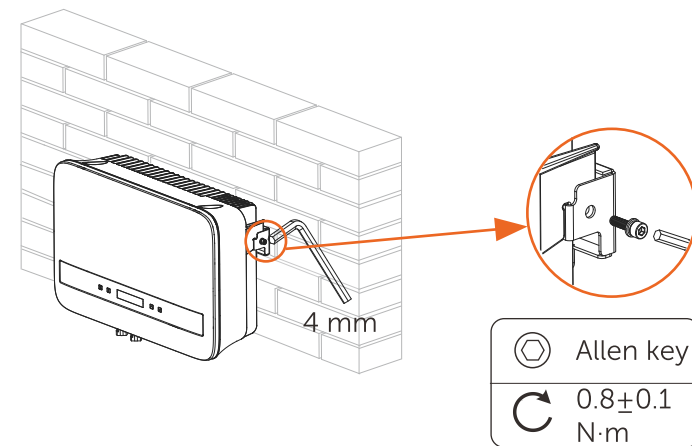

5.5 Connections of the Inverter

5.5.1 The Main Steps to Connect to the Inverter

> PV String Connection

The inverter has a couple of PV connectors which can be connected in series into 2-strings PV modules. Please select PV modules with excellent function and reliable quality. Open circuit voltage of module array connected should be <Max.DC (shown in table below) input voltage, and operating voltage should be within the MPPT voltage range.

Table 3 Max. DC Voltage Limitation

Model	X1-Boost-2.5K-G4	X1-Boost-3K-G4	X1-Boost-3.3K-G4	X1-Boost-3.6K-G4	X1-Boost-4.2K-G4	X1-Boost-5K-G4	X1-Boost-6K-G4
Max.DC Voltage	600V						

DANGER!
 Danger to life due to high voltages on DC conductors.

- When exposed to sunlight, the PV array generates dangerous DC voltage which is present in the DC conductors. Touching the DC conductors can lead to lethal electric shocks.
- Cover the PV modules.
- Do not touch the DC conductors.

WARNING!
 PV module voltage is very high which belongs to dangerous voltage range, please comply with the electric safety rules when connecting.

WARNING!
 Please do not ground PV positive or negative!

NOTE!
 Please follow the requirements of PV modules as below:

- Same type; Same quantity; Identical alignment; Identical tilt.
- In order to save cable and reduce the DC loss, we suggest installing the inverter near PV modules.

• Connection Steps

Tools below are needed before connection.

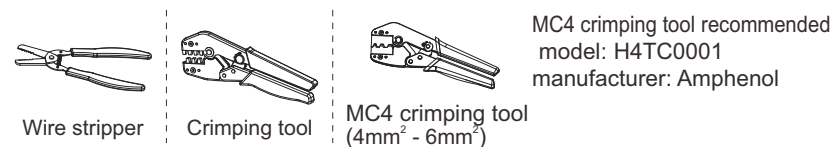

- Turn off the DC switch, then Choose 4mm² wire to connect the PV module.
- Strip 7mm of insulation from the wire end by using the wire stripper.

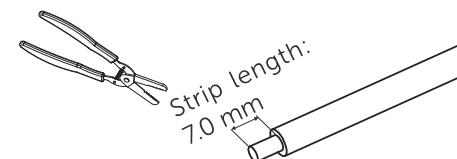

PV line: 4~6 mm² (2.5K~3.6K);
 5~6 mm² (4.2K~6K)

- Insert striped wire into pin contact and ensure all conductor strand are captured in the pin contact.

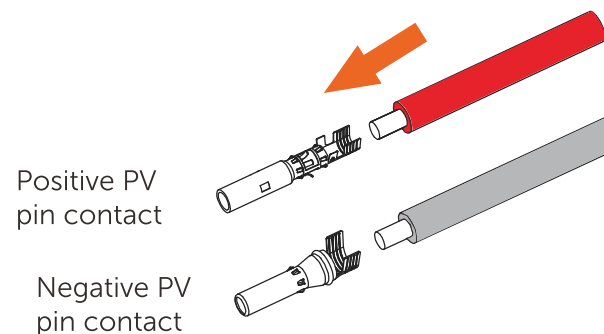

d) Crimp pin contact by using the MC4 crimping tool.

MC4 crimping tool
(4mm² - 6mm²)

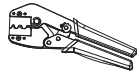

(recommended model: H4TC0001, manufacturer: Amphenol)

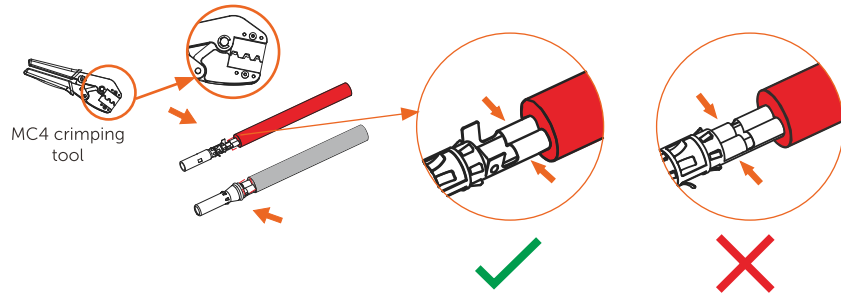

e) Separate the DC connector as two parts: the plug and the cable nut. Insert the wire into plug forcibly, when a "click" is felt or heard, the pin contact assembly is seated correctly.

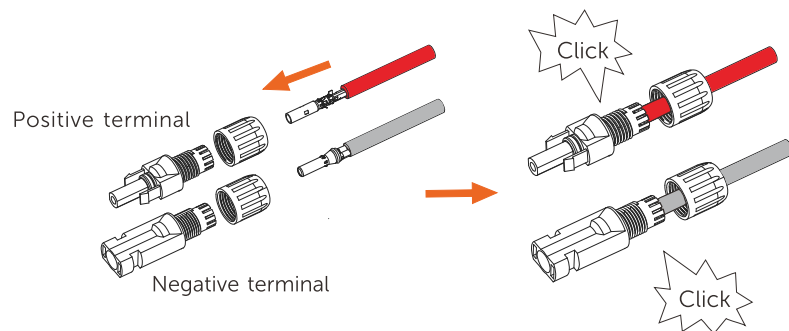

f) Then tighten the cable nut.

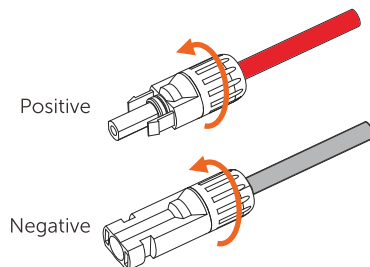

g) Use a multimeter to measure the open circuit voltage of the positive pole and negative pole of the PV cable, and make sure the open circuit voltage <600 V (Otherwise the machine may be damaged);

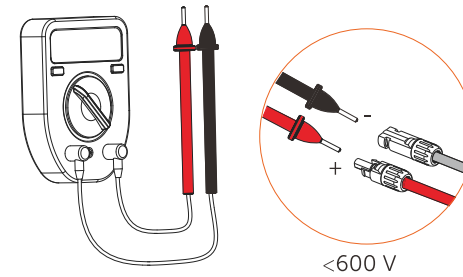

h) Remove the blue protective cover of the PV +&- interface at the bottom of the inverter, and insert the completed PV terminals according to the positive and negative correspondence.

i) Cover the remaining unused PV terminals with the original blue cover.

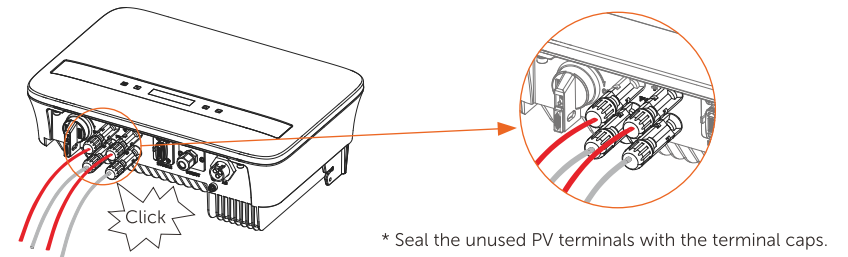

NOTE: Keep the DC switch of the inverter off during connection.

➤ Grid Connection

The inverter is designed for single phase grid. The nominal grid voltage is 220/ 230/ 240 V and the frequency is 50/ 60 Hz. Other technical requests should comply with the requirement of the local public grid.

Table 4 Cable and Micro-breaker recommended

Model	X1-BOOST-2.5K-G4	X1-BOOST-3K-G4	X1-BOOST-3.3K-G4	X1-BOOST-3.6K-G4	X1-BOOST-4.2K-G4	X1-BOOST-5K-G4	X1-BOOST-6K-G4
L,N Cable	4-6 mm ²	4-6 mm ²	4-6 mm ²	4-6 mm ²	5-6 mm ²	5-6 mm ²	5-6 mm ²
PE Cable	4-6 mm ²	4-6 mm ²	4-6 mm ²	4-6 mm ²	5-6 mm ²	5-6 mm ²	5-6 mm ²
Micro-breaker	20 A	20 A	20 A	20 A	25 A	32 A	32 A

The parameters vary because of different environment and material. Please choose appropriate cable and micro-breaker according to the local laws and regulations.



NOTE!
Inverters should not be used in multiple phase combinations.

Micro-breaker should be installed between inverter and grid, any loads should not be connected with inverter directly.

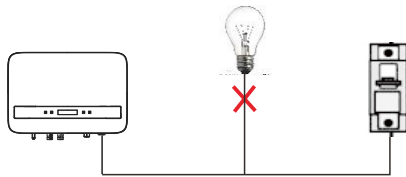

Incorrect Connection between Load and Inverter

• Connection Steps

- a) Check the grid voltage and compare with the permissive voltage range (refer to technical data).
- b) Disconnect the circuit-breaker from all the phases and secure against re-connection.
- c) Strip the wires:
 - Strip L and N wires to 52.5mm and the PE wire to 55mm.
 - Use the crimping pliers to strip 6mm of insulation from all wire ends as below.

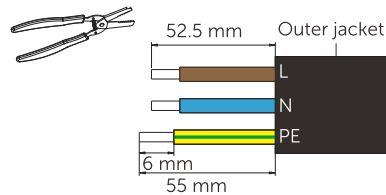

L/N/PE line: 4~6 mm² (2.5K~3.6K); 5~6 mm² (4.2K~6K)
* The cross-sectional area of PE line should be the same as that of L/N line.

- d) The AC connector provided in the packing list includes 2 parts (A and B).

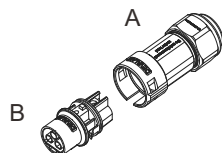

- Separate A into 2 components.

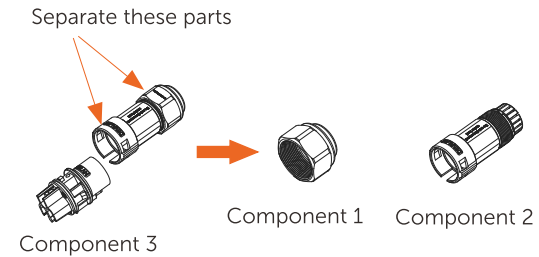

- Then the AC connector is finally classified into 3 components for use (as shown below).

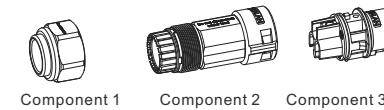

- e) Slide the component 1 and component 2 onto the cable.

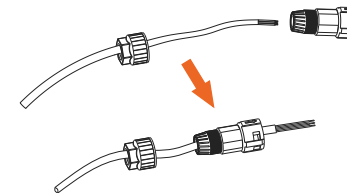

- f) Insert the stripped end of each three wires into the appropriate hole in the component 3, and then tight each screw (to tight each wire in place). (Allen wrench. Torque: 0.5±0.1N·m)

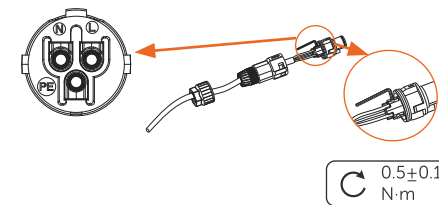

- g) Insert component 3 into component 2.

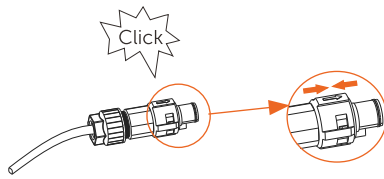

h) Screw down the component 1 tightly. (Torque: $3 \pm 0.3 \text{ N}\cdot\text{m}$)

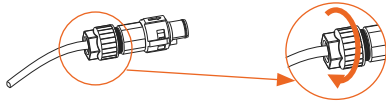

3 ± 0.3
N·m

i) Connect the AC plug to the inverter.

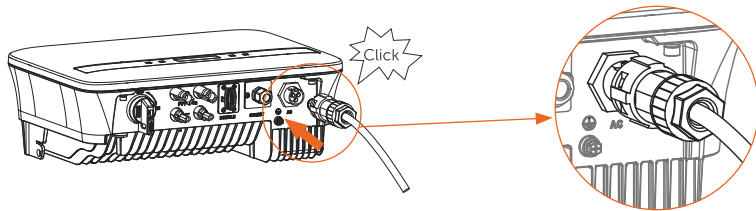

Selection of Fuses and Cables connection

Mini cable (AC line cable) shall have short circuit protection and thermal overload protection.

Always fit the input cable with fuse. Normal gGs (US: CC or T) fuses will protect the input cable in short circuit situation. They will also prevent damage to the adjoining equipment. Dimension the fuses according to local safety regulations, appropriate input voltage and the related current of the inverter.

AC output protected by external fuse (gG rated current 25 A/ 250 VAC for 3.0 KW/ 3.3 KW; 32 A/ 250 VAC for 3.6 KW/ 4.2 KW/ 5.0 KW/ 6.0 KW) provides in all live connections to the AC supply.

The rated short circuit breaking capacity of the above protective device shall be at least equal to the potential default current at the point of installation. See “technical data” section of this manual for details.

➤Earth Connection

Screw the ground screw with cross screwdriver as shown below.

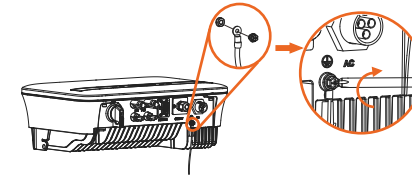

WARNING!
Be sure the ground wire must be connected!

Connection steps:

1) Use a crimping tool to strip the terminal from the PE cable.

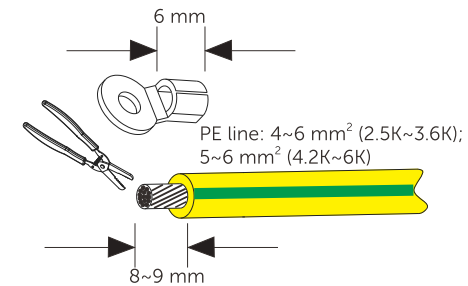

2) Slide the heat-shrink tubing over the PE cable. Then, insert the PE cable into the terminal, with length of the left side of the terminal less than 1.5 mm and the length of the right side of the terminal less than 2 mm.

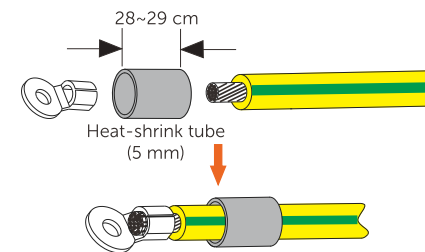

3) Use a crimping tool to squish the terminal.

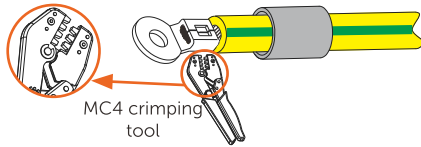

4) Use a hot-air blower to blow the heat-shrink tubing.

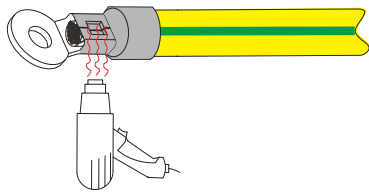

5) Screw the PE line using a cross screwdriver.

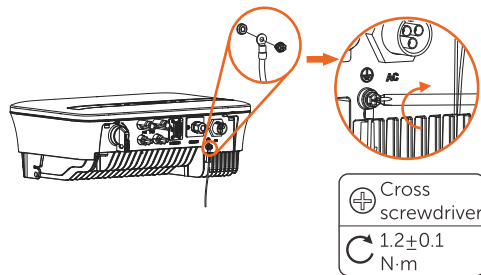

5.5.2 Communication interface

This product has a series of communication interfaces: such as DONGLE. COM/CT are used for communication and USB is used for Firmware updating. Operating information like output voltage, current, frequency, faulty information, etc., can be delivered to PC or other monitoring equipment via these interfaces.

DONGLE port

This inverter provides a DONGLE port which can collect information from inverter including status, performance and updating information to the monitoring website via connecting Wi-Fi Dongle (optional).

Connection steps:

1. Plug the WiFi Dongle (optional) into "DONGLE" port at the bottom of inverter.
 2. Connect the WiFi with router.
 3. Scan below QR code or search for the keyword "MonitoringCloud" in APP Store to download APP for setting up the monitoring.
 4. Follow the steps to create a new account, set up internet connections and check the inverter status.
- (For more details of the monitoring configuration, please refer to the WiFi/LAN/4G DONGLE user manual in the box.)

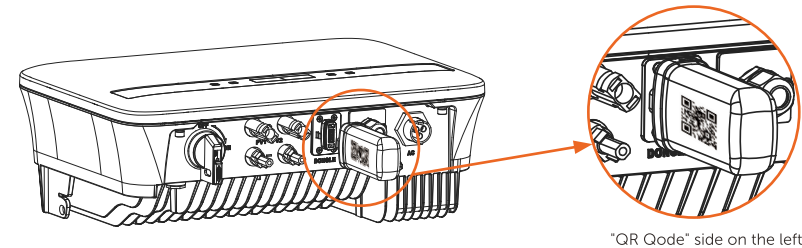

NOTE: WIFI module is optional. Whether WIFI module is included in the packing list depends on the actual situation.

COM/CT port

a. RS485 connection

RS485 is a standard communication interface which can transmit the real-time data from inverter to PC or other monitoring equipment.

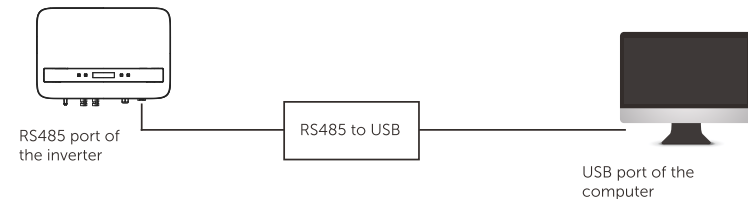

PIN	1	2	3	4	5	6	7	8
Definition	X	X	X	485_A	485_B	X	X	X

➤ RS485 Connection Steps:

- 1) Firstly unscrew all screws from the COM/CT port. (PH1 cross screwdriver . torque: $1.0 \pm 0.1 \text{N.m}$)
- 2) Prepare a communication cable and strip the insulation from it.
- 3) Let the communication cable pass through the waterproof connector, then insert it into the connector following the PIN definition rule.

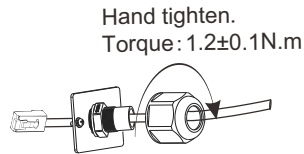

- 4) Crimp the connector with the crimping plier.
- 5) Insert the cable into the COM/CT port of the inverter, screw down the screw on the port and tighten the waterproof connector.

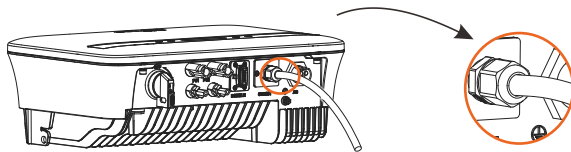

b. Meter/CT(optional)

NOTE!



It is recommended to connect our Smart meter to inverter. If there is no smart meter installed, please disable the "Export Control" function in the inverter setting. Otherwise the inverter will stop and report a "Meter fault" alert. The "Export Control" is disabled by default, if an error occurs, please check if it is disabled. The smart meter must be purchased from and authorized by us, any third party or non-authorized meter may not match with the inverter. We will not be liable for any loss and damage if the meter is unavailable or incompatible in this case.

With this single phase meter working together with the X1 series, you can:

- (1) Monitor the energy to grid and from grid through the whole day.
- (2) Achieve the export control function with a higher accuracy.

a. For meter without CT

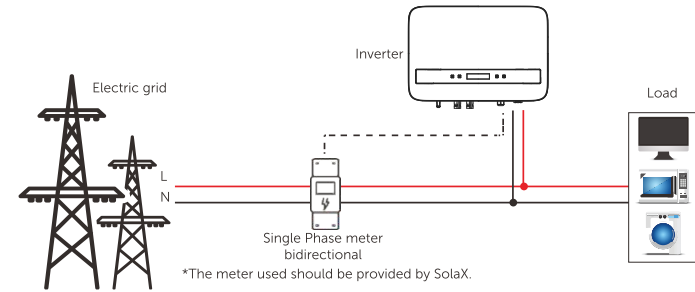

b. For meter with CT

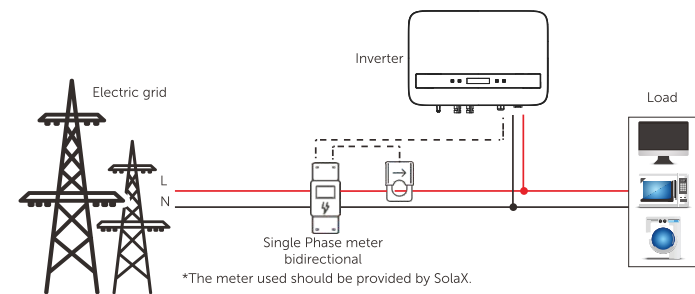

The PIN definition of Meter interface is shown as below.

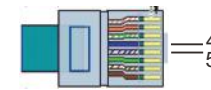

PIN	1	2	3	4	5	6	7	8
Definition	X	X	X	485_A	485_B	X	X	X

➤ CT Connection:

The current sensor measures the current on the phase wire that runs between the inverter and the grid.

• CT connection diagram

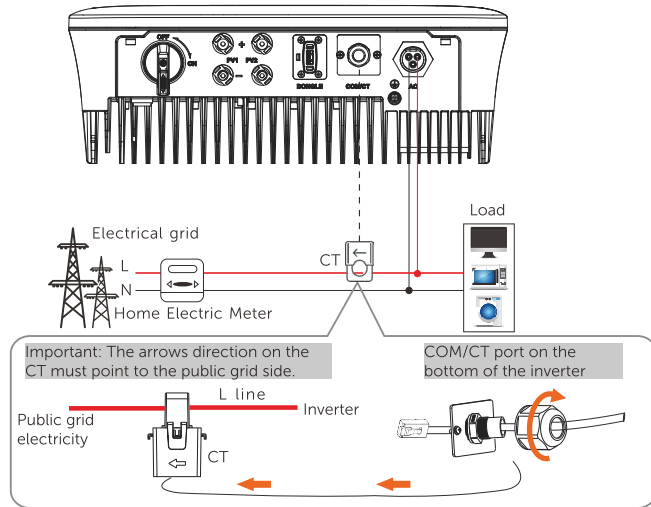

• CT PIN Definition

When connecting the RJ45 connector with the wire of the CT, please follow the sequence below :

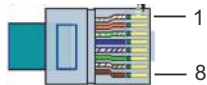

PIN	1	2	3	4	5	6	7	8
Definition	CT+	X	X	X	X	X	X	CT-

• CT Connection Steps:

NOTE!

- Do not place the CT on the N Wire or the earth wire.
- Do not place the CT on the N and L wire simultaneously.
- Do not place the CT with the arrow pointing to the inverter side.
- Do not place the CT on the non-insulated wires.
- Do not use the wire over 25m.



CT structural decomposition

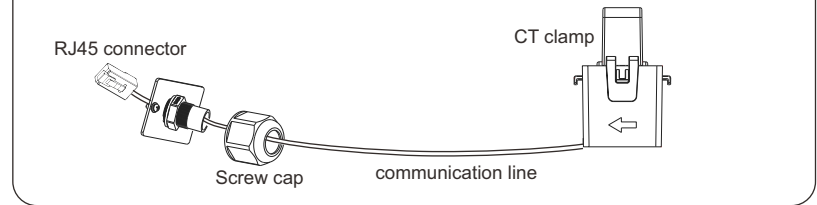

1. Insert the RJ45 connector of CT into the COM/CT port on the inverter, and screw down the screw cap tightly.
2. Clip the CT clamp on L line from the home main meter box side.
3. Make sure the current sensor is installed in the right direction: The arrow on the current sensor must point to the public grid.

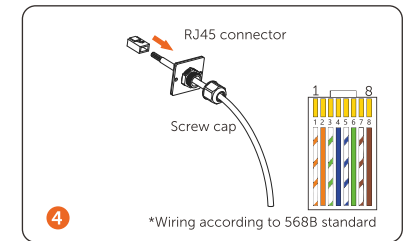
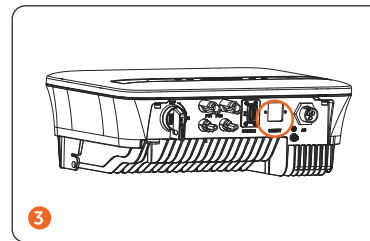
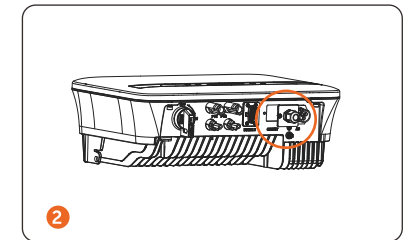
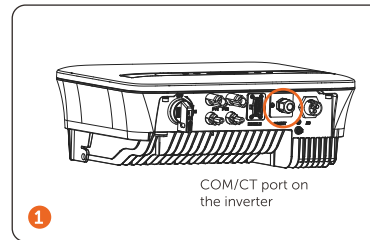

*Wiring according to 568B standard

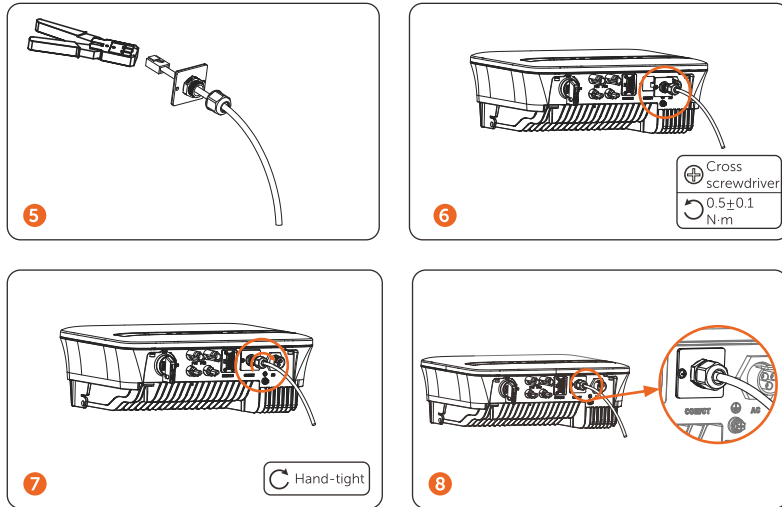

➤ DRM

DRM function (for AS4777) is provided to support several demand response modes by giving control signals as below (for other countries, DRM function is used for remote shut-off). The user should follow the following PIN rule and cooperate with external equipment when using it.

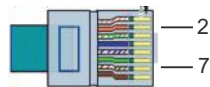

PIN	1	2	3	4	5	6	7	8
Definition	X	DRM0	X	X	X	X	+3.3V	X

DRM shares the terminal block with RS485/ Meter communications.

For the connection steps of the DRM, user can refer to the above (b) RS485 connections.

Note: Only DRM0 is available now. Remote shut off is available for countries and regions except Australia.

Heat Pump

Adapter box is provided to control the closing and breaking of switches by giving control signals. It can also be used to control heat pump via Adapter Box.

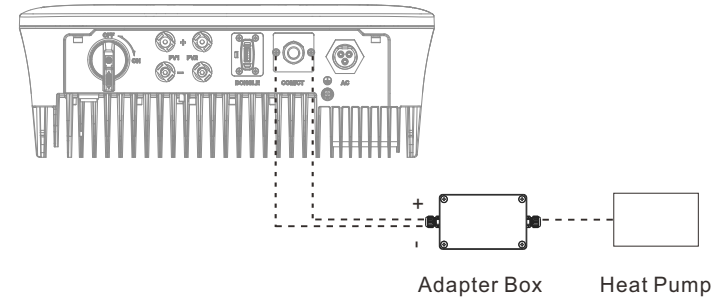

The PIN definition of heat pump is listed as below:

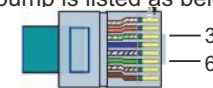

PIN	1	2	3	4	5	6	7	8
Definition	X	X	Heat Pump-	X	X	Heat Pump+	X	X

Heat Pump Connection:

1) Connect Heat Pump+ to the positive pole of the heat pump load and connect Heat Pump- to the negative pole of the heat pump load.

* The heat pump function is disabled by default. Please enable it in the setting.

Heat Pump Settings:

1) Enter the Settings interface and choose DryContact.

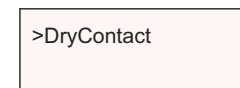
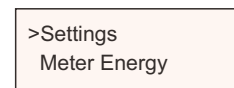

2) There are 2 modes for selection after you enter the DryContact interface:
Load Management and Generator.

(2.1) Choose Load Management and then select Manual in the Schedule interface.

(2.2) Choose On to switch on the heat pump function.

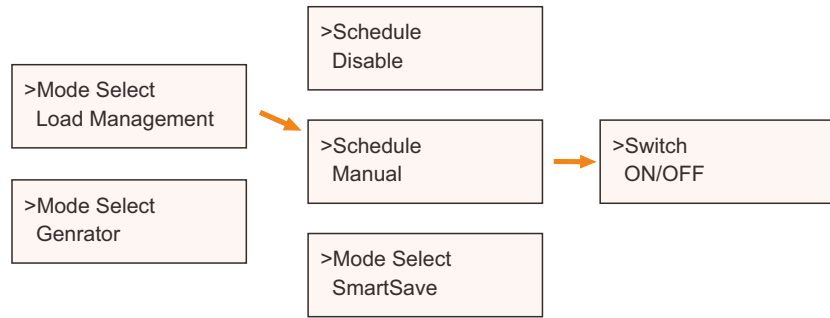

3) Set the time intervals for switching on/off the heat pump.

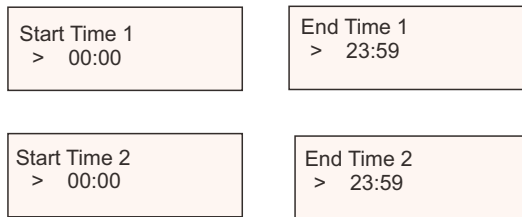

Parallel connection

The series inverter provides the parallel connection function, which could support several inverters to parallel in one system and can control zero injection to the grid with a meter installed in the main circuit.

The parallel system can be achieved with Modbus Function or with Datahub. Please refer to the following diagrams.

Diagram A: Parallel system with Modbus Function

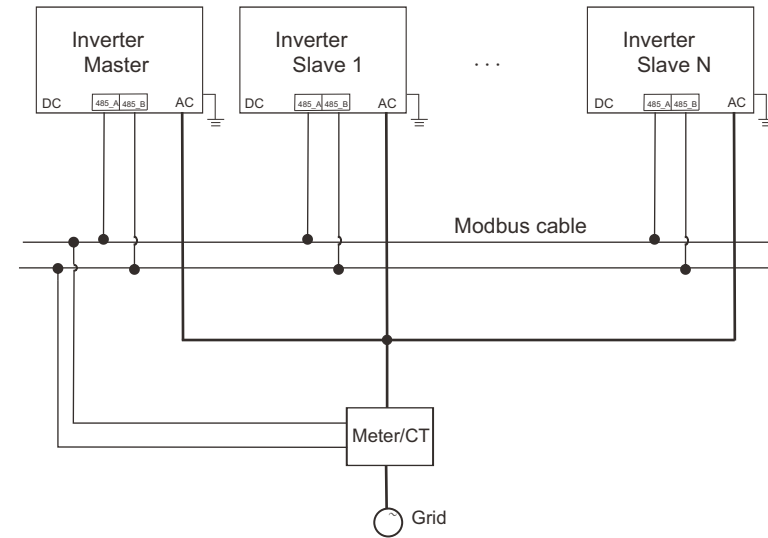
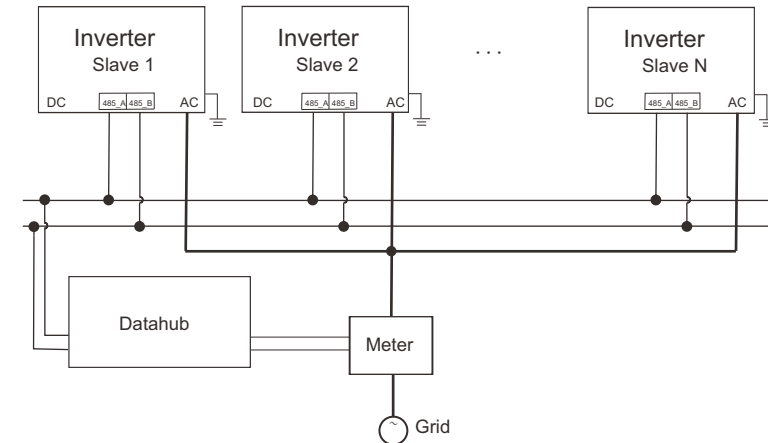



Diagram B: Parallel system with Datahub



NOTE!
 Before operation, please make sure that the inverters meet the following condition:
 1. All the inverters shall be the same series;
 2. The firmware version of all inverters shall be the same.
 Otherwise, the parallel function cannot be used.

➤ Parallel system with Modbus Function

In this parallel system, at most 5 inverters can be connected. One inverter will be set as a master, and the rest are the slaves. The master inverter can communicate with all the slave inverters.

• Wiring operation

- a) Connect all the inverters in the parallel system with each other via RS485 cables.
- b) Connect the communication cable with the master inverter.

• Setting

Turn on the power of the entire system, enter setting page of the inverters on the LCD screen. Follow the instructions below to finish the settings.

To set the master inverter:

- a) Enter “ParallelSetting” page, choose “Enable” to activate the function for the inverter.

> ParallelSetting MpptScanMode	> Parallel Switch Enable
-----------------------------------	-----------------------------

- b) Make sure the meter/CT is connected to the master inverter. Enter the “Export Control” page and choose “Meter”/“CT” on the master inverter.

> Export Control DRM Function	> Mode Select Meter
	> Mode Select CT

- c) Choose “M/S Mode” to select the Master inverter. Only one inverter can be set as “Master”.

> M/S Mode System Limit	> M/S Mode Master
----------------------------	----------------------

- d) Set the value for “System Limit” on the master inverter. This will be the overall power limit for parallel system. The output power of slaves will then be distributed respectively according to their nominal output power. The value can be set within the range of 0 kW to 30 kW and the default value is 0 W.

> System Limit 0

To set the slave inverters:

- a) Enter “Export Control” page, and the mode status is “Disable” by default (users cannot set by themselves).

> Export Control DRM Function	> Mode Select Disable
----------------------------------	--------------------------

- b) Choose “ParallelSetting” and then set the status of “Pallel Switch” as “Enable”.

> ParallelSetting MpptScanMode	> Parallel Switch Enable
-----------------------------------	-----------------------------

- c) Enter “M/S Mode” and chose “Slave” to set the Slave inverters.

> M/S Mode Slave

NOTE!
 The power limit value set in “System Limit” is the limit for the multiple inverters in the parallel system, while the “UserValue” set in “Export Control” is the power limit for a single inverter which will be nullified when the parallel function is enabled.

NOTE!
 The parallel system with Modbus Function and the EV-Charger function cannot be used at the same time currently. If the EVCharger is connected when multiple inverters are working in the parallel system:
 When the "ParallelSetting" is enabled, the inverter communication with EV-Charger would be interrupted. In this case, the EV-Charger should have its own CT/Meter installed to work properly with parallel inverters.
 When the "ParallelSetting" is disabled, the EV-Charger function is enabled, then the EV-Charger can work normally with the inverter it is connected to, while other inverters cannot realize the export control function.



➤ Parallel system with Datahub

In this parallel system, at most 60 inverters can be connected. The Datahub will be the master of the system, and all the inverters are the slaves. The Datahub can communicate with all the slave inverters.

NOTE!
 Before connecting the Datahub to the parallel system, please check that the inverters' settings meet the following conditions:
 The "ParallelSetting" should be "Disable".
 The addresses of all the inverters should be different.
 Otherwise, please reset the RS485 communication addresses.
 The communication address of meter and inverter mustn't be the same, otherwise a conflict may arise.



➤ Wiring operation

- a) Connect one terminal of an RS485 communication cable with Datahub, and the other end with one of the slave inverters.
- b) Connect all the slave inverters with each other via RS485 cables.
- c) Connect the meter with the Datahub and the mains.

NOTE!
 The inverter connected with the Datahub should not enable the "ParallelSetting".
 There is no need to set the "ParallelSetting" on the inverters, the parallel system with Datahub will start automatically.



For the details, please refer to the user manual of Datahub.

EV-Charger Function

The inverter can communicate with the smart EV-Charger to form an intelligent photovoltaic, storage and EV charging energy system, thus maximizing the utilization of photovoltaic energy.

Diagram: Intelligent Photovoltaic, Storage and EV Charging Energy System

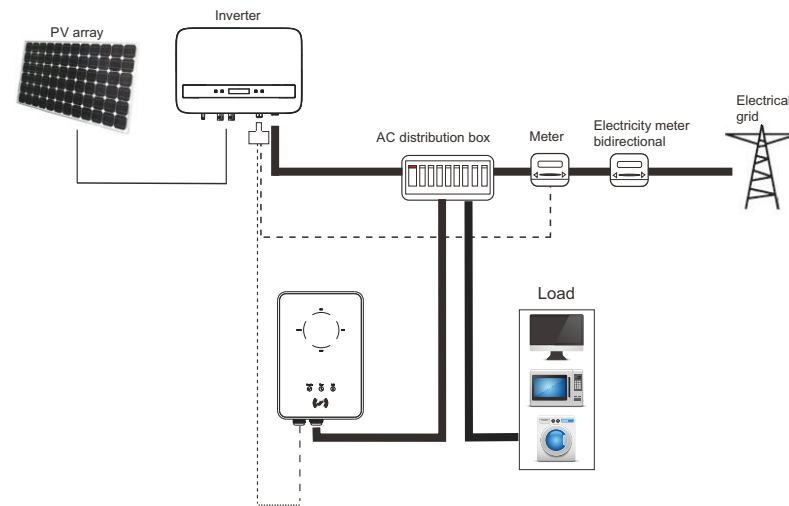

• Wiring operation

- a) Plug one terminal of the communication cable to the right pin of the EV-Charger and the other terminal to PIN 4 & 5 of the "COM/CT" port of the inverter.
- b) Connect the meter to PIN 4 & 5 of the "COM/CT" port of the inverter.

• Setting

Turn on the power of the entire system, enter the "Settings" page of the inverters on the LCD screen.

- a) Enter the "Export Control" page and chose "CT" or "Meter".

> Export Control
 DRM Function

> Mode Select
 Meter

> Mode Select
 CT

b) Select "EvChargerEnable" and then enter "Mode Select". Ensure the interface shows "Enable" under "Mode Select", which indicate the EV-Charger function started successfully.

> EvChargerEnable
Earth Detect

> Mode Select
Enable

For the installation and settings of the EV-Charger, please refer to the user manual of the EV-Charger for details.

NOTE!
The EV-Charger function and the parallel system with Datahub or the parallel system with Modbus Function cannot be used at the same time currently.

④ Upgrade

User can update the inverter system through the U-disk.

WARNING!
Make sure the input voltage is more than 65 VDC (in good illumination condition), or it may result in failing during updating.

> Upgrade Steps:

1) Please contact our service to get the latest firmware. Then add a new folder named "Update" in the root directory on your U-disk, and two more sub-folders named "ARM" and "DSP" under "Update". Please copy the firmware files into ARM and DSP respectively. It will be like:
"Update\ARM\323101021300_X1_BOOST_G4_XX_XXXXX_XXXX_XX
X_ARM_Vxxx.xx_XXXXXXXXXXXXXXXXX.bin";
"Update\DSP\323101021400_X1_BOOST_G4_XX_XXXXX_XXXX_XX
X_DSP_Vxxx.xx_XXXXXXXXXXXXXXXXX.bin"

WARNING!

- Make sure the directory is in accordance with above form strictly!
- Do not modify the program file name! Or it may cause the inverter does not work anymore!

3) Then insert U-disk into the DONGLE port on the bottom of the inverter. Then turn on DC switch or connect the PV connector, the LCD interface will show as below.

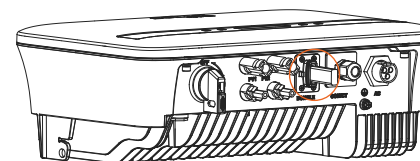

4) Press up and down to select the one that you want to update and long press down to confirm.

5) When the upgrade is completed, please remember to turn off the AC switch and DC switch (optional), then pull off the U-disk.

WARNING!
During updating, please don't turn off the DC switch or disconnect the PV connector. If failed, please repeat the above operation again.

5.6 Run the Inverter

•Start inverter after checking all steps below:

- a) Check that device is fixed well on the wall.
- b) Make sure all the DC breakers and AC breakers are disconnected.
- c) AC cable is connected to grid correctly.
- d) The DC cable is properly and reliably connected;
- e) The ground cable is properly and reliably connected;
- f) The communication cable is properly and reliably connected.
- g) All PV panels are connected to inverter correctly, DC connectors which are not used should be sealed by cover.
- h) No foreign items, such as tools, are left on the top of the machine or in the junction box (if any).
- l) Turn on the DC switch (optional) to the “ON” position.
- j) First turn on the external AC and then DC connectors.

•Start the inverter

- Inverter will start automatically when PV panels generate enough energy.
- Check the status of LED indicators and LCD screen, the LED indicators should be blue and the LCD screen should display the main interface.
- If the LED indication is not blue, please check the conditions below:
 - All the connections are right.
 - All the external disconnect switches are closed.
 - The DC switch of the inverter is in the “ON” position.
 - If the red light flashes, which means an error occurs, please check if the above conditions are met.

The following is the three status when operating, which means inverter starting up successfully.

Status	Description
Waiting	Inverter is waiting to check the voltage.
Checking	Inverter will check DC input environment automatically when DC input voltage from the PV panels exceeds 50 V and PV panels have enough energy to start inverter.
Normal	Inverter begins to operate normally when the blue light is constantly on. Meanwhile feedback energy to grid, LCD displays present output power.

Enter the setting interface to follow the instructions when it is first time to start up.



WARNING!
Power to the unit must be turned on only after installation work has been completed. All electrical connections must be carried out by qualified personnel in accordance with legislation in force in the country concerned.



NOTE!
Please set the inverter according to local requirements.

5.7 Isolation Fault Alarm

The inverter has the isolation fault alarm function as required by AS 4777_2020 and New Zealand. It will give an visual alarm, you will see that the red light is flickering and the IsoFault will show on the LCD of inverter once the Insulation impedance of the PV arrays is less than 20 KΩ

- Please select Australia Region A, B, C for power quality response modes and grid protection settings during commissioning.
- You can adjust setpoints for power quality response modes and grid protection settings if required.

5.8 Commissioning

- Firmware version
- Region settings (and setpoints) for grid protection settings
- Region settings (and setpoints) for power quality response modes.

NOTE!
 Once settings are selected at commissioning they are locked to view only.

NOTE!
 Password should not be readily available – if you need that, you can find the password that either in a separate maintenance/service manual or available from manufacturer/importer upon request.

6. Operation Method

6.1 Control panel

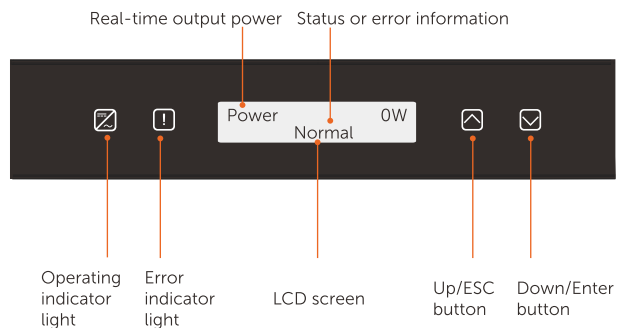

Item	Description
LCD Screen	Display the information of the inverter.
Operating indicator light	Light in blue: The inverter is in normal status. Flash in blue: The inverter is in waiting status.
Error indicator	Light in red: The inverter is in fault status.
Up/ESC button	Up/ESC button: Short press to move cursor up or increase value; Long press to return from current interface or function.
Down/Enter button	Down/Enter button: Short press to move the cursor down or decrease value. Long press to confirm and change the parameters.

Note: When the inverter is in “Waiting” and “Checking” status, the blue light “B” is flickering; when it is in “Normal” status, the blue light “B” is always on.

6.2 LCD Structure

Please refer to the inverter for the most updated structure

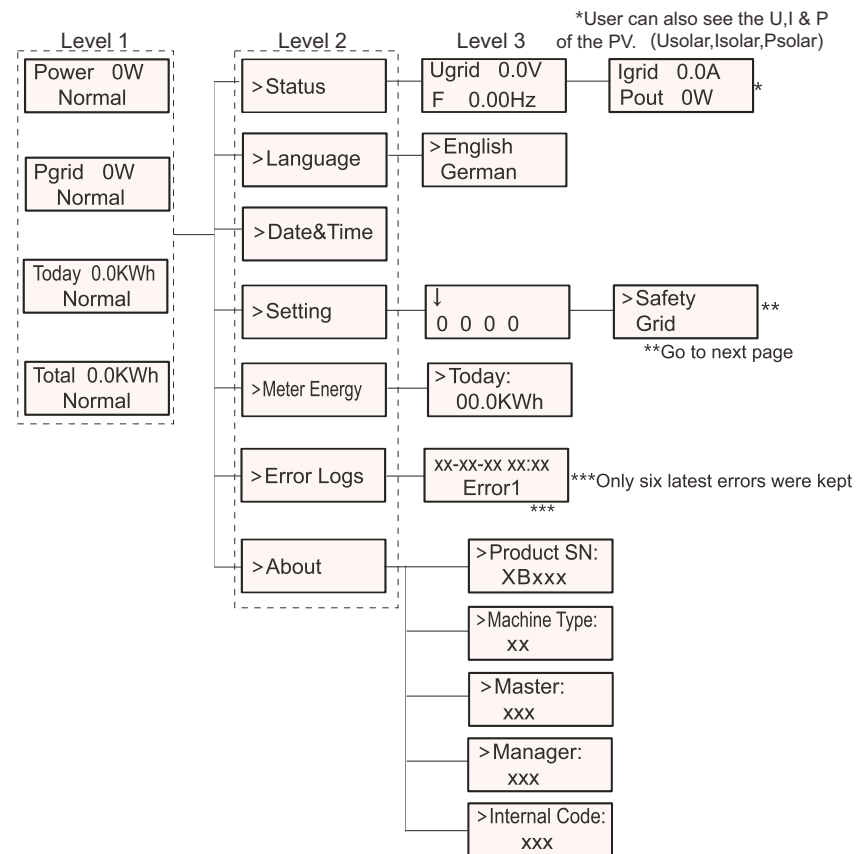

Note:

Key	Operation	Description
Enter/Down	Long Press	Go to the next menu or confirm to change parameters
	Short Press	Browse the next parameter or increase the value
Back/Up	Long Press	Return the previous menu or confirm the parameters
	Short Press	Browse the previous parameter or decrease the value

6.3 LCD Operation

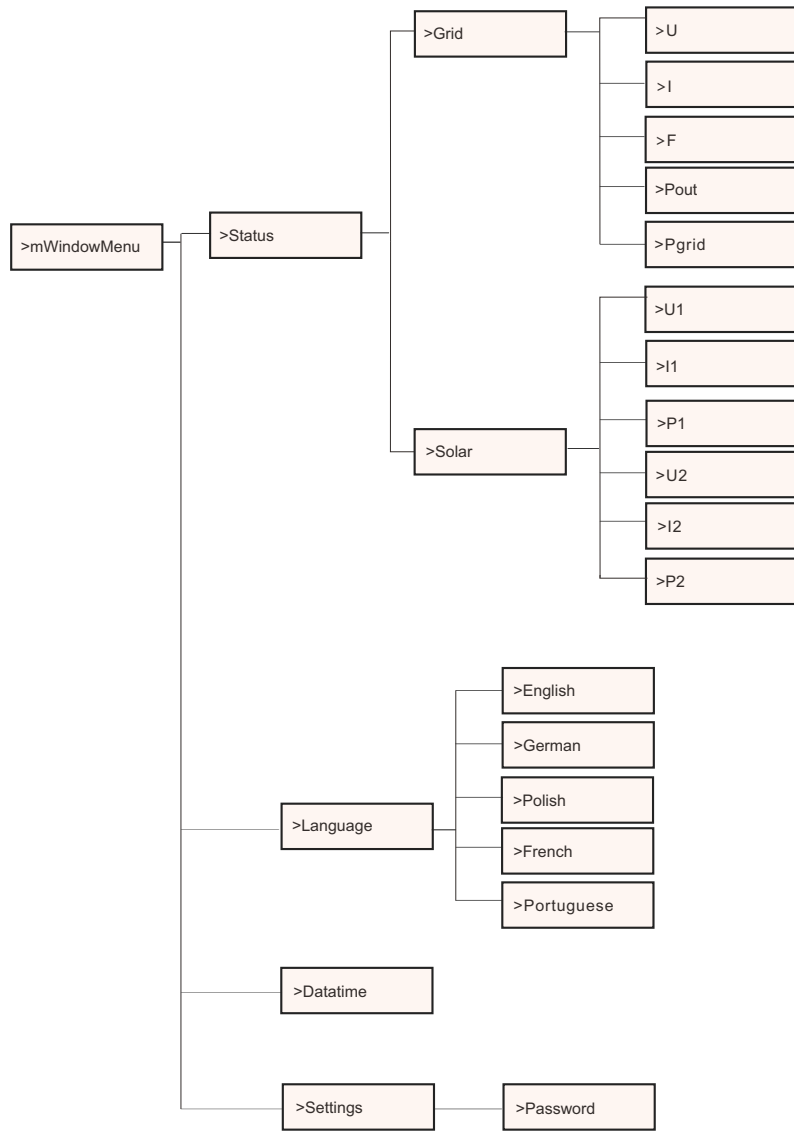

** **Go to next page

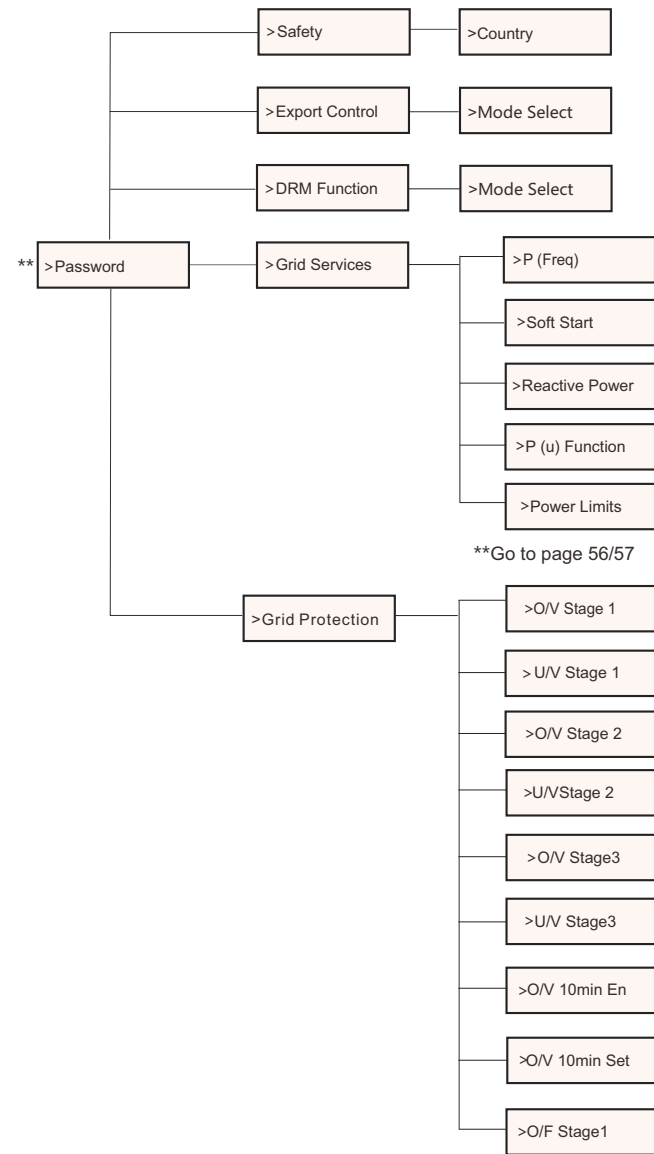

**Go to page 56/57

**Go to next page

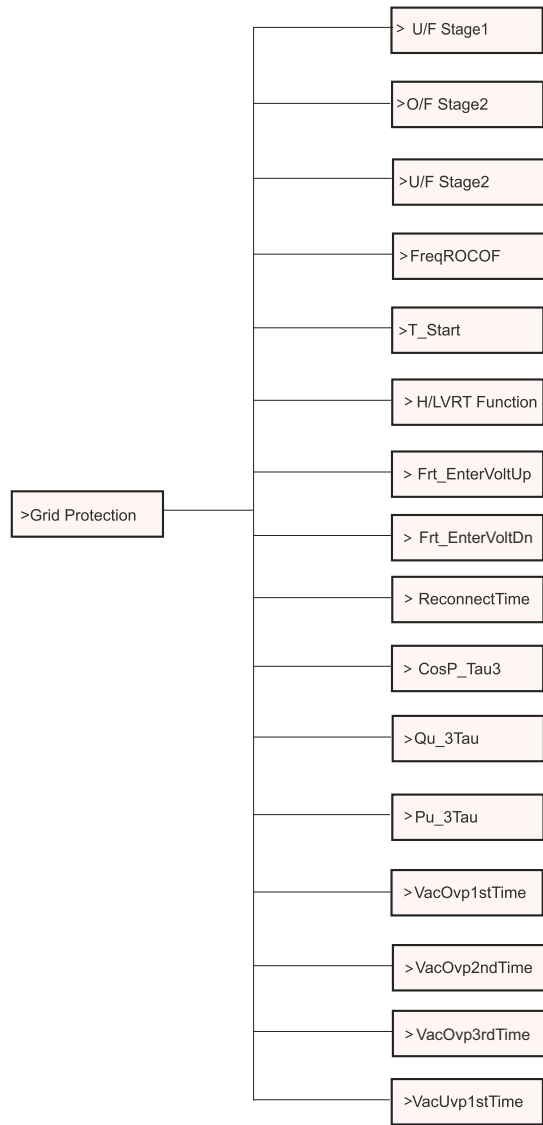

**Go to next page

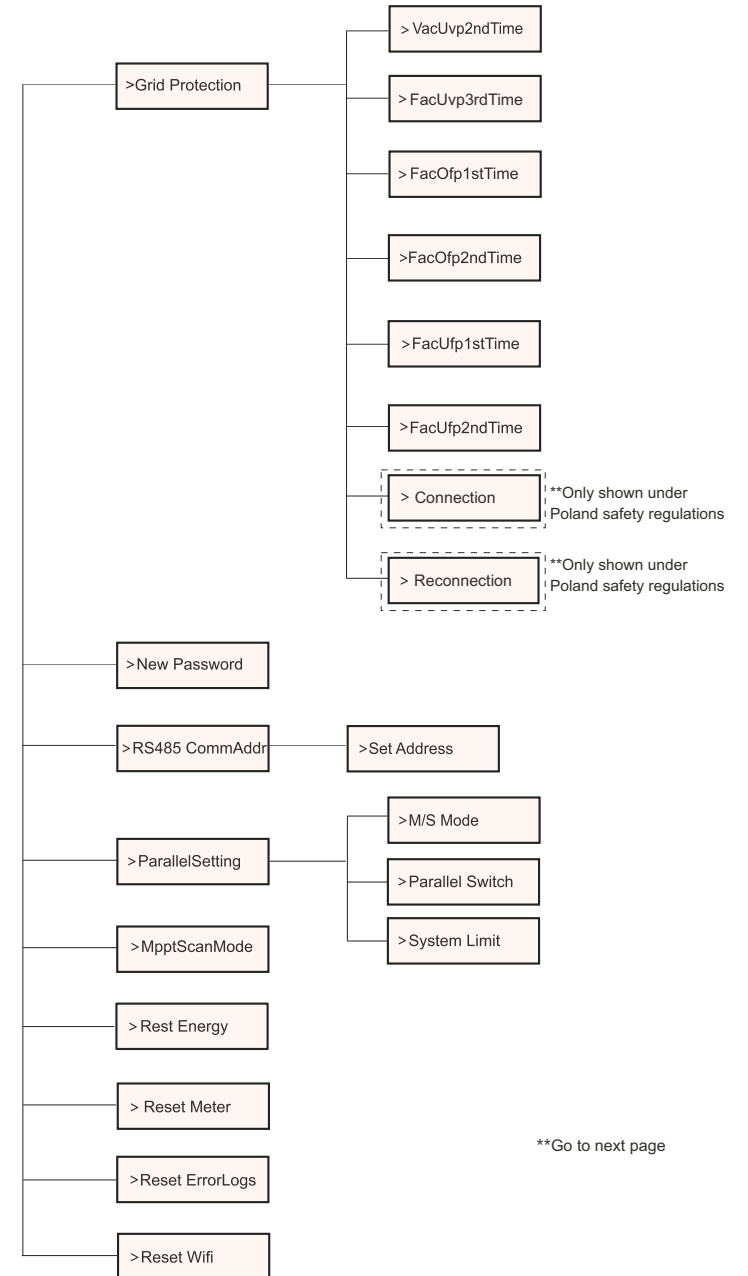

**Go to next page

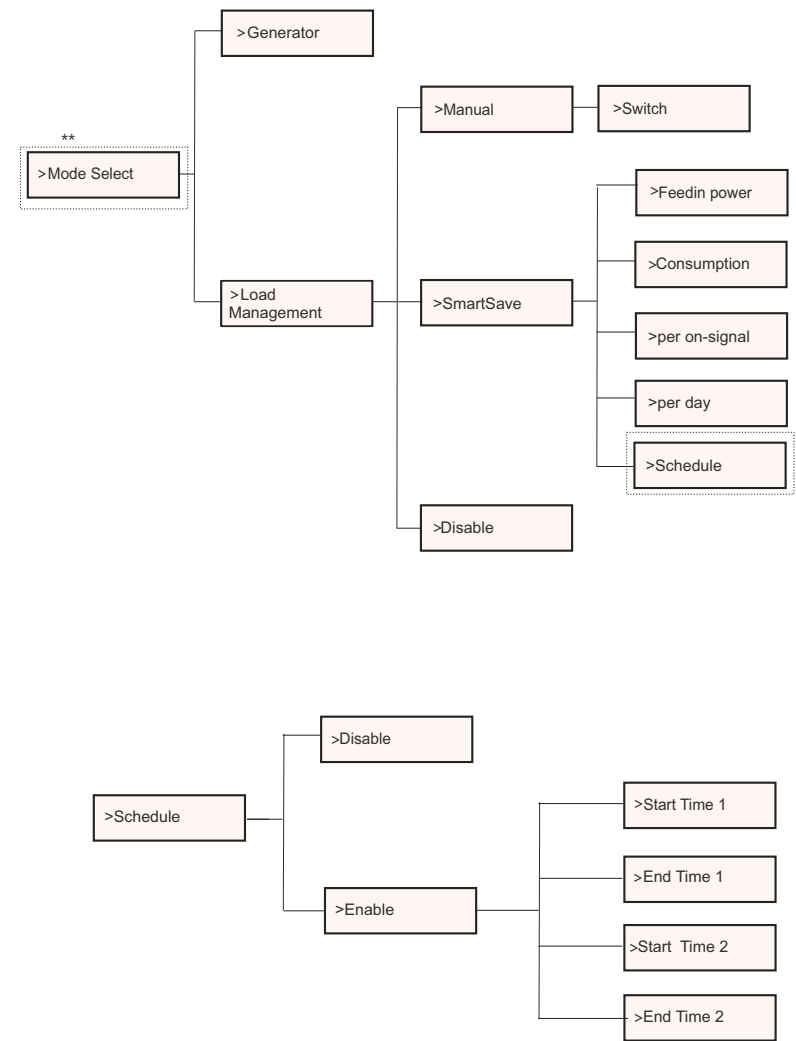
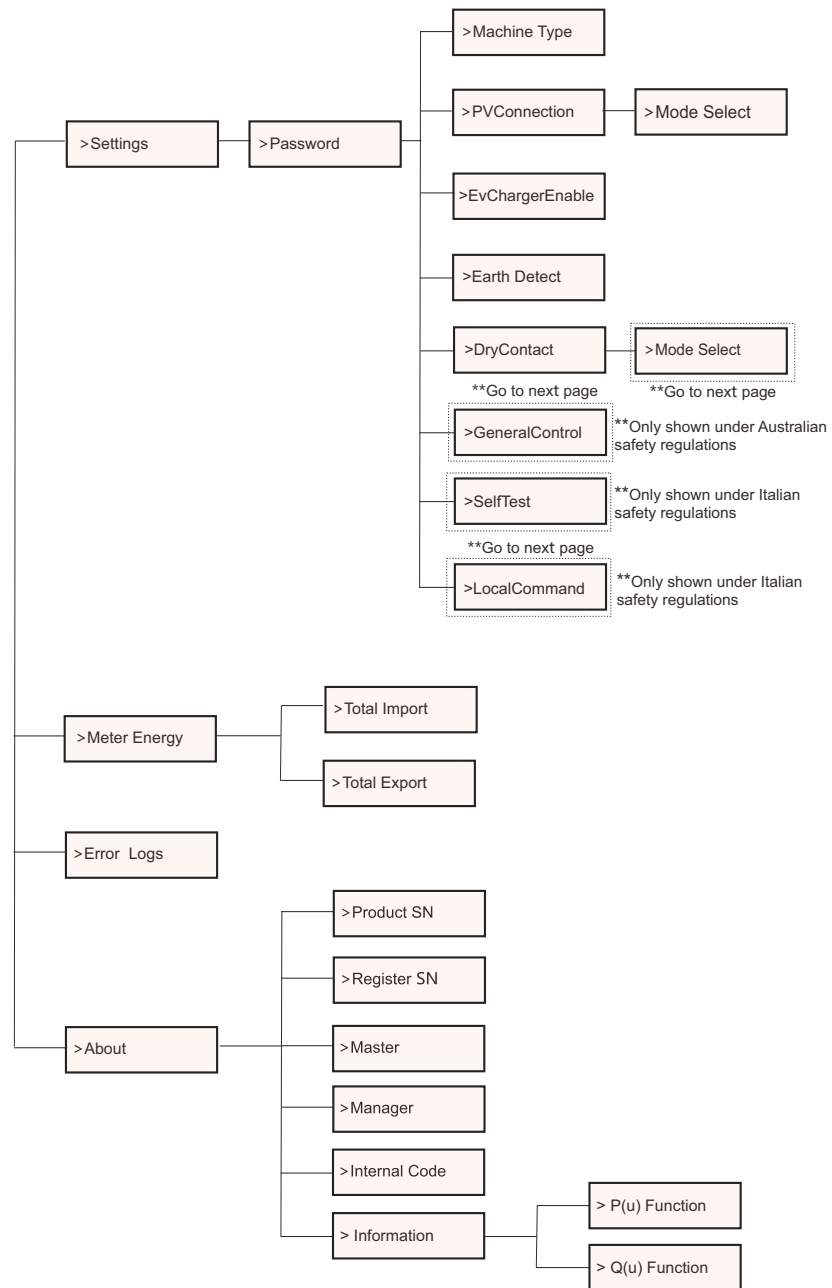

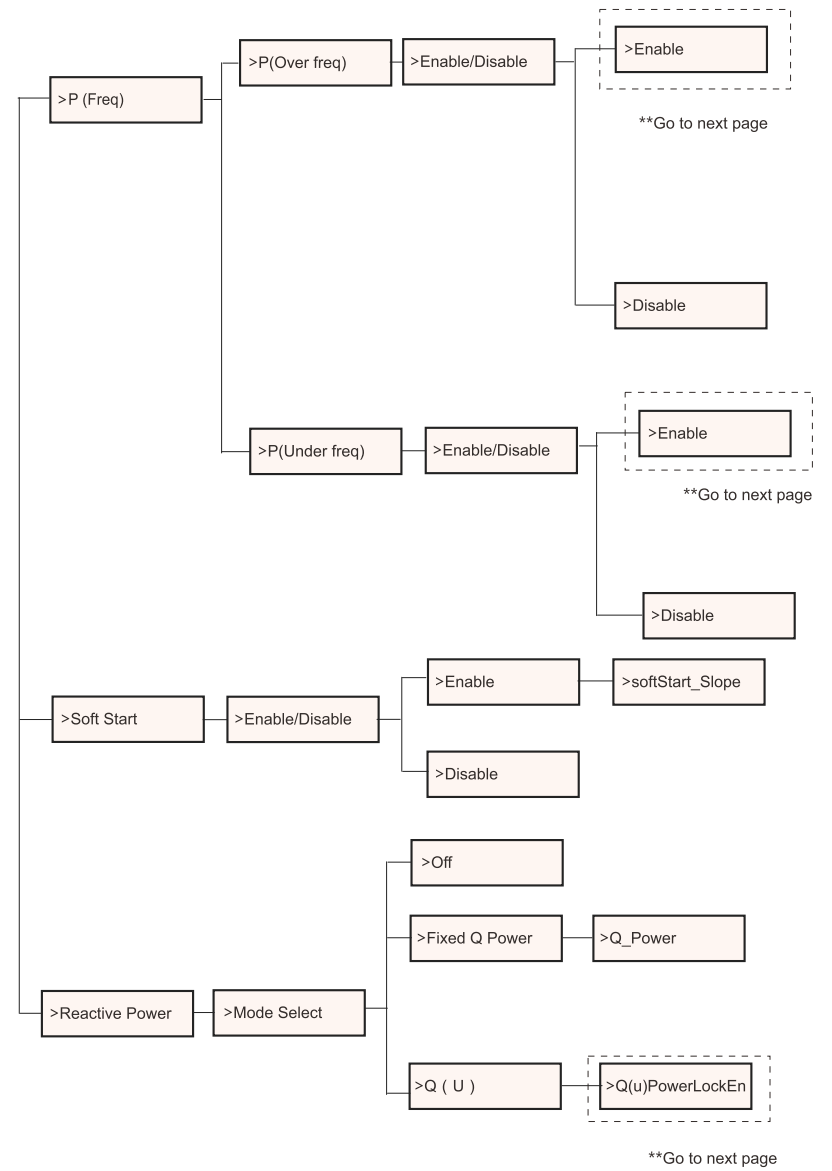
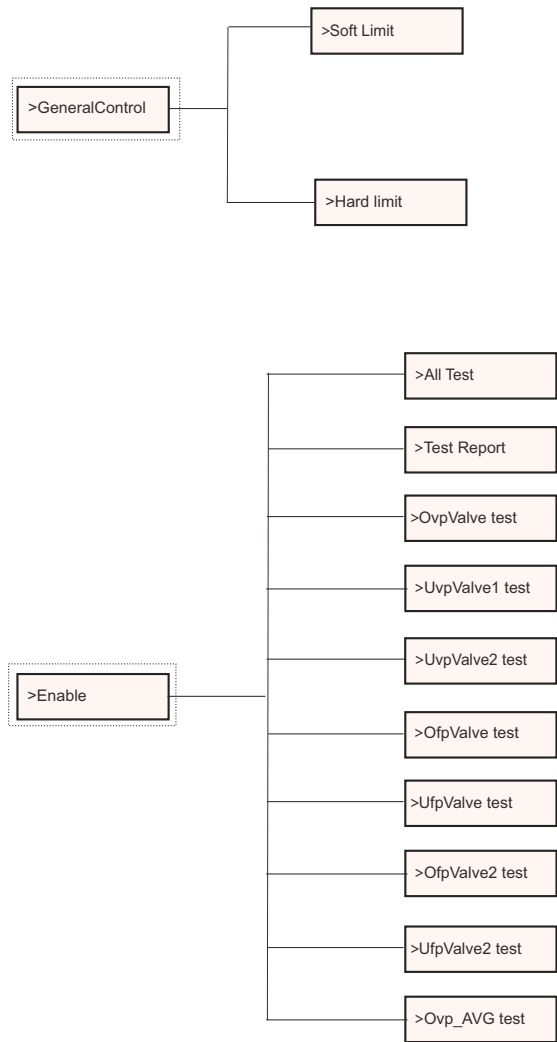

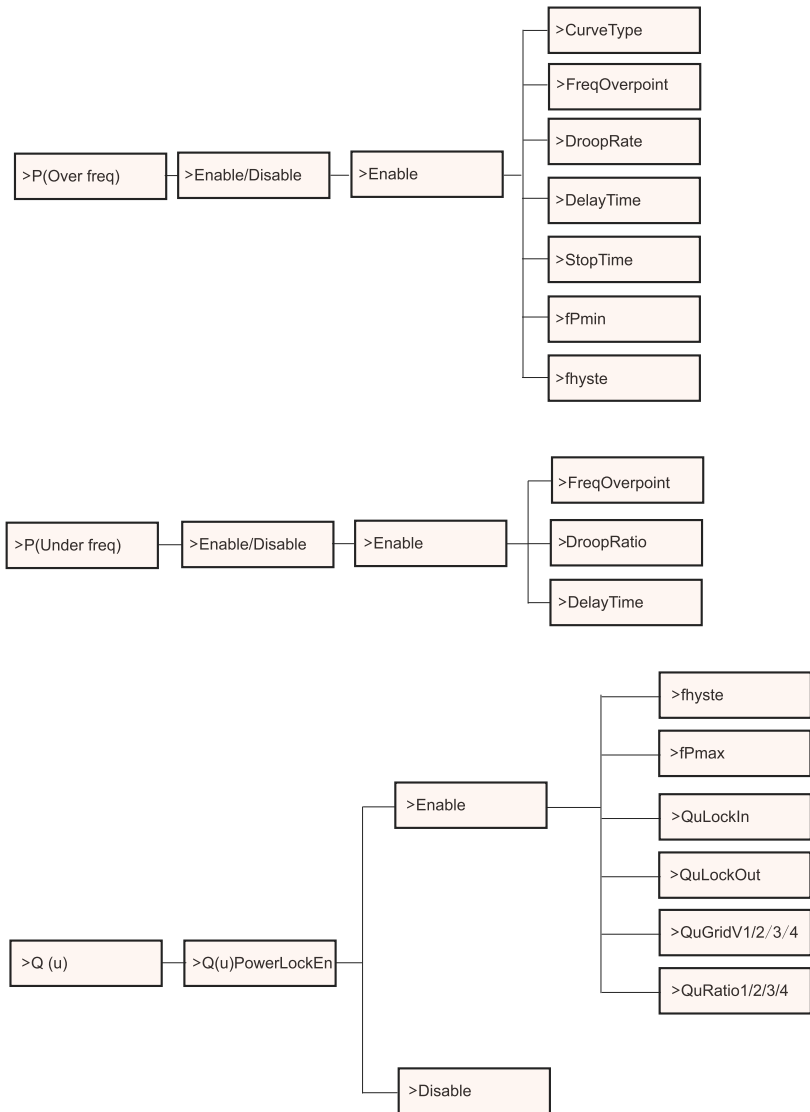

LCD Display

Level 1



1) The first line displays the parameters(Power, Pgrid, Today and Total) and the values.

Parameter	Meaning
Power	The output power of inverter.
Pgrid	The power export to or import from the grid; (Positive value means the energy feeds into grid, negative value means the energy used from the grid)
Today	The power generated within the day.
Total	The power generated in total.

2) The second line shows the running status.

“Normal” means the running status of the inverter.

Level 2

Long press the “Enter” button to enter the second-level interface. User can see parameters, such as the Status, Language, Date Time, Settings (need password), Meter energy (including Total Import, Total Export), Error Logs (of the inverter), and About (the user can browse the information of the inverter, including product serial number, machine type, register sn, master, slave, manager and internal code).

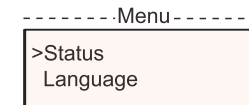

a) Status

The status function contains two aspects: the grid and the solar. Press “Up” and “Down” to select and long press “down” to confirm the selection, long press “Up” to return to Menu.

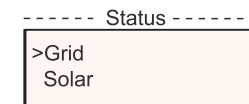

1) Grid

This status shows the current condition of the AC output port of the inverter, such as voltage, current, output power and grid power.

This status includes 5 parameters: U, I, F, Pout, Pgrid.

Press “Up” and “Down” button to browse the parameter, long press “up” to return to Status.

----- Grid -----	
>U	0.0V
I	0.0A

2) Solar

This status shows the real time PV condition of the system, such as input voltage, current and power situation of each PV input.

This status includes 6 parameters: U1, I1,P1, U2, I2, P2.

Press “Up” and “Down” button to browse the parameter, long press “up” to return to Status.

----- Solar -----	
>U1	0.0V
I1	0.0A

b) Language

The function refers to select a language from English, German, Polish, French, Portuguese, etc.

---- Language ----	
>English	
German	

c) Date Time

This interface is for the user to set the system date and time. Increase or decrease the word by pressing “Up” or “Down” button. Long press “Down” to confirm and alternate to next parameter. After all the numbers are confirmed. Long press “Down” to enter the date and time.

-----Date&Time-----	
>2000-01-01	
00 : 00	

d) Settings

This function is used for setting the inverter.

----- Settings -----	
↓	
0 0 0 0	

* Password

The default password is “2014” for the installer, which only allows the installer to review and modify necessary settings complying to the local rules and regulations. If further advanced setting is required, please contact the distributor or us for assistance. We need to increase or decrease the word by pressing up or down button. Long press “Down” to confirm and alternate to the next number.

---- Settings ----	
↓	
1 0 0 0	

After entering password, the LCD interface is shown as below:

---- Settings -----	
>Safety	
Export Control	

1) Safety

The user can set the safety standard here according to different countries and grid tied standards. There are several standards for choice (May change without notice). In addition, the user has an “UserDefined” option which allows the user to customize relevant parameters within a wider range.

----- Safety -----	
>Country	
VDE4105	

 **NOTE!**
The grid standard needs to be set as different regions according to local requirements. If there is any doubt, please consult our service technicians for details.

The default settings for different regions are shown as follows:

Region	Australia A	Australia B	Australia C	New Zealand	
Standard Code Name	AS4777_2020_A	AS4777_2020_B	AS4777_2020_C	New Zealand	Setting Range
OV-G-V	265V	265V	265V	265V	230-300V
OV-GV1-T	1.5S	1.5S	1.5S	1.5S	
OV-G-V2	275V	275V	275V	275V	230-300V
OV-GV2-T	0.1S	0.1S	0.1S	0.1S	
UN-G-V1	180V	180V	180V	180V	40-230V
UNGV1T	10S	10S	10S	10S	
UN-G-V2	70V	70V	70V	70V	40-230V
UNGV2T	1.5S	1.5S	1.5S	1.5S	
OV-G-F1	52Hz	52Hz	55Hz	55Hz	50-55Hz
OVGF4T	0.1S	0.1S	0.1S	0.1S	
OV-G-F2	52Hz	52Hz	55Hz	55Hz	50-55Hz
OVGF2T	0.1S	0.1S	0.1S	0.1S	
UN-G-F1	47Hz	47Hz	45Hz	45Hz	45-50Hz
UNGF1T	1.5S	1.5S	5S	1.5S	
UN-G-F2	47Hz	47Hz	45Hz	45Hz	45-50Hz
UNGF2T	1.5S	1.5S	5S	1.5S	
Startup-T	60S	60S	60S	60S	15-1000S
Restore-T	60S	60S	60S	60S	15-600S
Recover-VH	253V	253V	253V	253V	
Recover-VL	205V	205V	205V	198V	
Recover-FH	50.15Hz	50.15Hz	50.15Hz	50.15Hz	
Recover-FL	47.5Hz	47.5Hz	47.5Hz	47.5Hz	
Start-VH	253V	253V	253V	253V	
Start-VL	205V	205V	205V	198V	
Start-FH	50.15Hz	50.15Hz	50.15Hz	50.15Hz	
Start-FL	47.5Hz	47.5Hz	47.5Hz	47.5Hz	

2) Export Control

With this function the inverter can control energy exported to the grid.

Whether having this function is based on user's wishes.

Choose "Disable" means the function will be shut off.

The user value set by installer must be within the range of 0 kW to 60 kW.

Press "Up" and "Down" button to select and long press "Down" to confirm.

-- Export Control ----
>Mode Select
CT/Meter/Disable

3) DRM Function

Installer can choose "Enable" to control the inverter's power off through external communication.

--- DRM Function ----
>DRM Function
Enable/Disable

4) Grid Services

Usually end user do not need to set the grid parameters. All default value have been set before leaving factory according to safety rules.

If reset is needed, any changes should be made according to the requirements of local grid.

--- Grid Service -----
>P (freq)
Soft Start

1. ----- P(freq) -----
>P(Overfreq)
P(Underfreq)
If reset is needed, any changes should be made according to the requirements of local grid.

2. ----- Soft Start -----
>Enable/Disable
>Disable <
If reset is needed, any changes should be made according to the requirements of local grid.

3.
>Soft Start_Slope
9%
If set as shown, 9 percent of the rated power increase per minute.

4-1.

---- Reactive Power --

>Mode Select
>Off<

If reset is needed, any changes should be made according to the requirements of local grid.

Mode Select	Comment
Off	-
Over-Excited	PF value
Under-Excited	PF value
PF(P)	PowerFactor1(2/3/4)
	PowerRatio1(2/3/4)
	EntryVolt
	ExitVolt
Q(u)	Q(u)PowerLockEn
	Q(u) LockIn
	Q(u) LockOut
	Q(u) GridV1/V2/V3/V4
Fix Q Power	Q Power



NOTE!

The terms shown in the interface depend on the local safety regulations.

4-2.

Reactive power control, Reactive standard curve $\cos \phi = f(P)$

For VDE ARN 4105, curve $\cos \phi = f(P)$ should refer to curve A. Default values of setting are as shown in curve A.

For E 8001, curve $\cos \phi = f(P)$ should refer to curve B. Default values of setting are as shown in curve B.

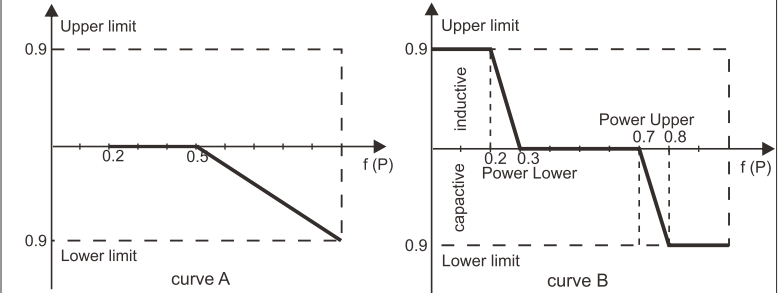

Reactive power control, Reactive standard curve $Q = f(V)$

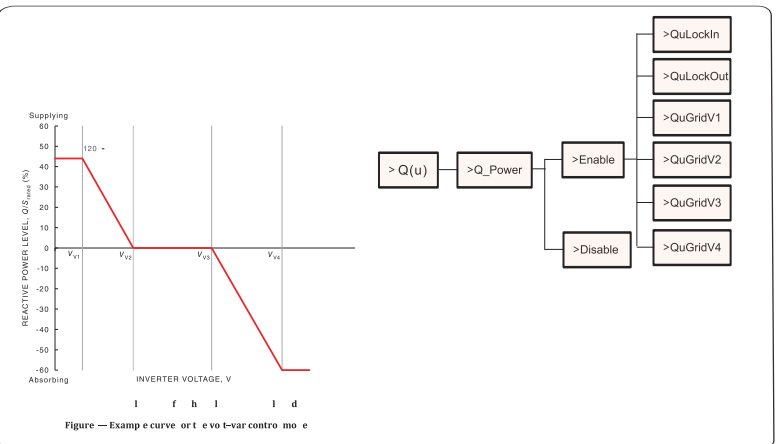
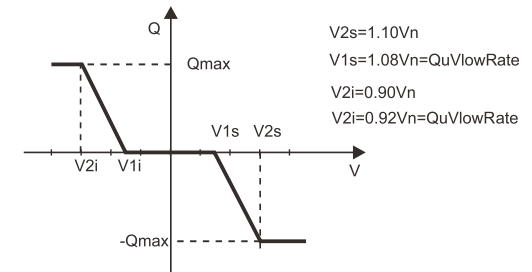
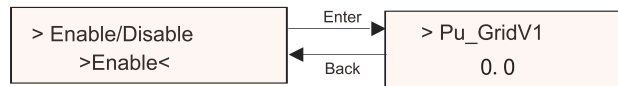

Figure — Example curve of voltage control mode

Voltage 1(Vv1): 180-230V
 (Default: AS4777_2020_A(207V);AS4777_2020_B(205V);AS4777_2020_C(215V);New Zealand(207V))
 Voltage 2(Vv2): 180-230V
 (Default: AS4777_2020_A(220V);AS4777_2020_B(220V);AS4777_2020_C(230V);New Zealand(220V))
 Q-Limit 2(Vv2): 0%
 Voltage 3(Vv3): 230V-265V
 (Default: AS4777_2020_A(240V);AS4777_2020_B(235V);AS4777_2020_C(240V);New Zealand(235V))
 Q-Limit 3(Vv3): 0%
 Voltage 4(Vv4): 230V-265V
 (Default: AS4777_2020_A(258V);AS4777_2020_B(255V);AS4777_2020_C(255V);New Zealand(244V))
 "Vv1" Leading(Supplying): +30~+60%
 (Default: AS4777_2020_A(+44%);AS4777_2020_B(+30%);AS4777_2020_C(+44%);New Zealand(+60%))
 Lagging(Absorbing): -30~-60%
 (Default: AS4777_2020_A(-60%);AS4777_2020_B(-40%);AS4777_2020_C(-60%);New Zealand(-60%))

5. ----- P(u) Function -----



This function can limit the power. There are several values to be set.

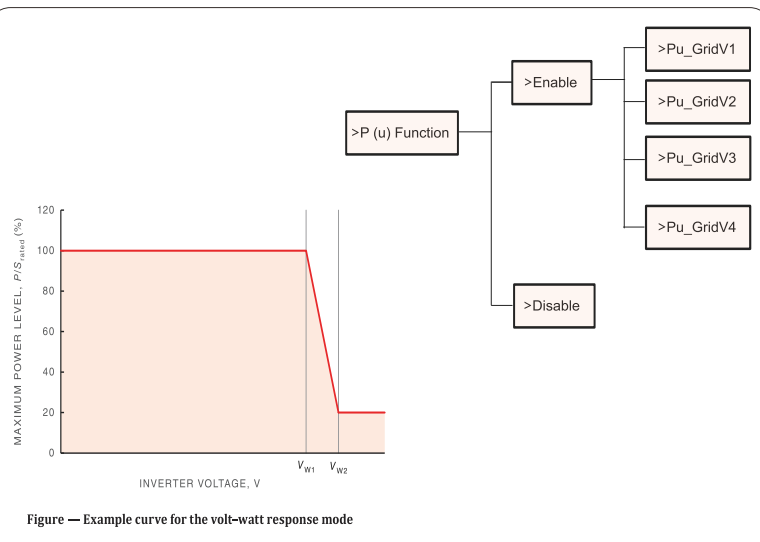
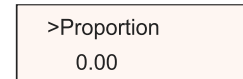

Figure — Example curve for the volt-watt response mode

Status:Enable/Disable (Note:This is used to enable or disable the Volt-Watt mode)
 Voltage 1(Vw1): 235V-255V
 (Default: AS4777_2020_ A(253V); AS4777_2020_ B (250V); AS4777_2020_ C(253V); New Zealand(242V))
 P-Limit 1(Vw1): 100%
 Voltage 2(Vw2): 240V-265V
 (Default: AS4777_2020_ A (260V); AS4777_2020_ B (260V); AS4777_2020_ C(260V); New Zealand(250V))
 P-Limit 2(Vw2): 0-20%(Default: 20% for AS4777_2020_ A; AS4777_2020_ B ; AS4777_2020_ C; New Zealand)

6. ----- Power Limits -----



User can set the power limit here, the setting value is between 0.00 and 1.1.

5) Grid Protection

Usually end user do not need to set the grid Protection. All default values have been set before leaving factory according to safety rules. If reset is needed, any changes should be made according to the requirements of local grid.

----- Export Control -----

```

> O/V Stage1
0.0
    
```

6) New Password

The user can set the new password here. We need to increase or decrease the word by pressing “Up” or “Down” button. Long press “Down” to confirm and alternate to next word. After word is confirmed, long press “Down” to reset the password.

----- New Password -----

```

>
0 0 0 0
    
```

7) RS485 CommAddr

If “Enable” is selected, the inverter will communicate with the computer, through which the operating status of the inverter can be monitored. When multiple inverters are monitored by one computer, RS485 communication addresses of different inverters need to be set. RS485 function will only be effective when the address is identical. The default address is “1”.

----- RS485 CommAddr -----

```

>Set Address
1
    
```

8) ParallelSetting

When the user wants to use the parallel system with Modbus Function, enable this function and complete the settings following the instructions in section “Parallel Connection”. If not needed, disable this function.

----- ParallelSetting -----

```

> Parallel Switch
Enable
    
```

9) Mppt Scan Mode

There are 4 modes for selection: “off”, “LowFreqScan”, “MidFreqScan”, “HighFreqScan”. It shows the frequency of PV panel scan. If “LowFreqScan” is selected, the inverter will scan the PV panel by low frequency. Time for LowFreqScan: 4h; for MidFreqScan: 3h; for HighFreqScan: 1h.

----- Mppt Scan Mode -----

```

Mode Select
>Off<
    
```

10) Reset Energy

The user can clear the power energy of CT and meter by this function (if the user uses CT or meter).

----- Reset Energy -----

```

> Reset
>YES/NO<
    
```

11) Reset Meter

The user can clear the meter energy by this function. Press “Up” or “Down” button to select and long press “Down” to confirm. (The user can select “Yes” to reset meter if the user uses meter)

----- Reset Meter -----

```

> Reset
>YES/NO<
    
```

12) Reset Errorlog

The user can clear the errorlogs by this function. Press “Up” or “Down” button to select and long press “Down” to confirm.

----- Reset Errorlog -----

```

> Reset
>YES/NO<
    
```

13) Reset WiFi

The user can restart the WiFi by this function.

----- Reset WiFi -----

```

> Reset
>YES/NO<
    
```

14) Machine Type

The user can check the Machine Type by this function.

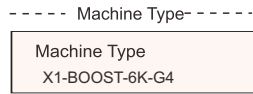

15) PVConnection

The user can select the PV connection type by this function.

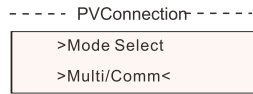

16) EvChargerEnable

The user can turn on EvCharger function by select "Enable".

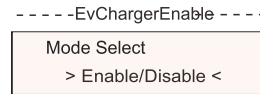

17) Earth Detect

The user can enable or disable the Earth Detect by this function. Earth Detect is disabled by default.

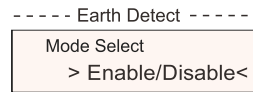

18) Dry Contact

The user can use the Dry Contact to connect heat pump by this function (require SG Ready).



There are three functions(Disable/Manual/Smart Save) which can be selected for Load Management. "Disable" means the heat pump is off. When "Manual" is selected the user can control the external relay to remain close or open manually. "Smart Save" mode can set the values of the heat pump's on/o fftime and conditions, operating modes.

If the user uses the inverter dry contacts to control heat pump through Adapter box, please refer to the Adapter Box Quick Installation Guide to set the parameters here.

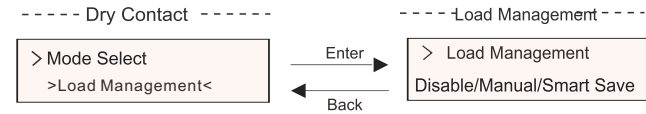

e) Meter Energy

The user can check the import and export energy by this function. There are 2 parameters: "Total Import" and "Total Export". Press "UP" or "DOWN" button to review the values.

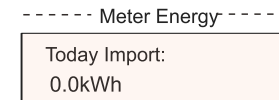

f) Error Logs

The Error log contains error information happened. It can record 5 items at most. Press "Up" and "Down" button to review parameter. Long press "up" to return to the main interface.

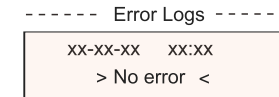

g) About

This interface shows information of the inverter, including "Product SN", "Master", "Manager" and "Internal Code".

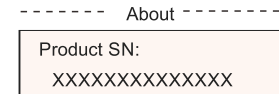

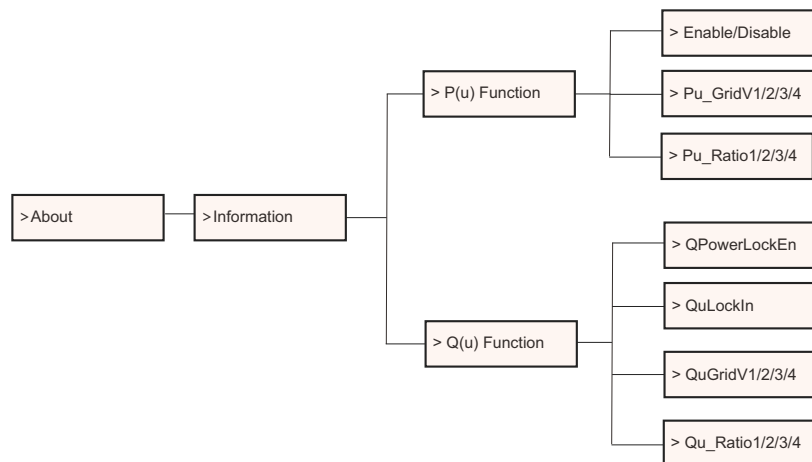

Level 3

Long press the “Enter” button to enter the third-level interface.

- a) Status: The user can see the U/I/P parameters of the grid and the PV, such as the Ugrid, Igrid, P and F of the grid, and the Usolar, Isolar and Psolar of the PV.
- b) Language: This inverter provides several languages for customer to choose.
- c) Settings: Entering the installer password, the information of the LCD interface is shown in the previous page.
 - (1) Safety: The user can set the right safety standard here.
 - (2) Grid: Usually end user do not need to set the grid parameters.

If you need to reset, any changes should comply with the requirement of local grid.

Parameter	Comment
Para	
O/V Stage1	Slow overvoltage point
U/V Stage1	Slow undervoltage point
O/V Stage2	Rapid overvoltage point
U/V Stage2	Rapid undervoltage point
O/V Stage3	Stage-3 rapid overvoltage point
U/V Stage3	Stage-3 rapid undervoltage point
O/V 10min En	10 min average overvoltage enabled
O/V 10min Set	10 min average overvoltage setting value
O/F Stage1	Slow overfrequency point
U/F Stage1	Slow underfrequency point
O/F Stage2	Rapid overfrequency point
U/F Stage1	Rapid underfrequency point
FreqROCOF	Rate of frequency change
T_Start	Self-test time
H/LVRT Function	High/low voltage ride enabled
FrT_EnterVoltDn	Entry value of low voltage ride through
FrT_EnterVoltUp	Entry value of high voltage ride through
Qu_3Tau	Reactive step response time constant
Pu_3Tau	Active step response time constant
VacOVP1stTime	Stage-1 overvoltage protection time
VacOVP2ndTime	Stage-2 overvoltage protection time
VacOVP3rdTime	Stage-3 overvoltage protection time
VacUVP1stTime	Stage-1 undervoltage protection time
VacUVP2ndTime	Stage-2 undervoltage protection time
VacUVP3rdTime	Stage-3 undervoltage protection time
FacOFF1stTime	Stage-1 overfrequency protection time
FacOFF2ndTime	Stage-2 overfrequency protection time
FacUFP1stTime	Stage-1 underfrequency protection time
FacUFP2ndTime	Stage-2 underfrequency protection time

NOTE!
The specific safety regulations depend on the local safety regulations.

(3) Power Factor: (For specific country if required by the local grid.)
 There are 6 modes for selecting: Off, Under-Excited, Over-Excited, PF (p),
 Q (u).
 All parameters are shown below.

Mode	Comment
Off	
Under excited	PF Value
Over excited	PF Value
PF(p)	PowerFactor1
	PowerFactor2
	PowerFactor3
	PowerFactor4
	PowerRatio1
	PowerRatio2
	PowerRatio3
	PowerRatio4
Q(u)	QuLockIn
	QuLockOut
	QuGridV1
	QuGridV2
	QuGridV3
QuGridV4	
Fixed Q Power	Q Power

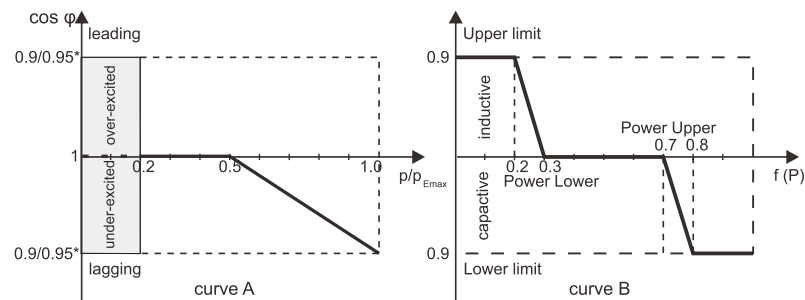

For VDE 4105, curve $\cos \phi = f(P)$ should refer to curve A. The default setting values are as shown in curve A.
 For TOR, curve $\cos \phi = f(P)$ should refer to curve B. default values of setting are as shown in curve B.

7 Troubleshooting

7.1 Troubleshooting

This section contains information and procedures for solving possible problems of our inverter, and provides you with troubleshooting tips to identify and solve most problems that could occur with the inverter.

This section will help you narrow down the source of any problems you may encounter. Please read the following troubleshooting steps.

Check warnings or fault messages on System Control Panel or Fault codes on the inverter information panel. If a message is displayed, record it before doing anything further.

Attempt the solution indicated in troubleshooting lists.

* If your inverter's information panel is not displaying a Fault light, check the following list to make sure that the present state of the installation allows proper operation of the unit.

- Is the inverter located in a clean, dry, adequately ventilated place?
- Have the DC input breakers been opened?
- Are the cables adequately sized and short enough?
- Are the input and output connections and wiring in good condition?
- Are the configurations settings correct for your particular installation?
- Are the display panel and the communications cable properly connected and undamaged?

Contact our Customer Service for further assistance. Please be prepared to describe details of your system installation and provide model and serial number of the unit.

Code	Faults	Diagnosis and solution
IE:00001	TzFault	Over Current Fault. -Wait for about 10 seconds to check if the inverter is back to normal. -Disconnect the DC switch and restart the inverter. -Or consult us for solutions.
IE:00002	GridLostFault	Grid Lost Fault. -Check if the mains cable is loose. -Wait for a while and the system will reconnect when the utility is back to normal. -Or consult us for solutions.
IE:00003 IE:00004 IE:00005	GridVoltFault	Grid Voltage Out of Range. -Check if the mains cable is loose. -Wait for a while and the system will reconnect when the utility is back to normal. -Or consult us for solutions.
IE:00006 IE:00007 IE:00008	GridFreqFault	Grid Frequency Out of Range. -Wait for a while and the system will reconnect when the utility is back to normal. -Or consult us for solutions.
IE:00009	PVVoltFault	PV Voltage Fault. -Check whether the PV is overvoltage. -Or consult us for solutions.
IE:00010 IE:00051 IE:00052	BusVoltFault	DC Bus Voltage Out of Normal Range. -Check if the PV input voltage is within the operating range of the inverter. -Disconnect PV wiring and reconnect. -Or consult us for solutions.
IE:00012	GridVolt10MFAult	Grid Overvoltage for Ten Minutes Fault. -The system will reconnect when the utility is back to normal. -Or consult us for solutions.
IE:00013	DclnjOCP	DCI Overcurrent Protection Fault. -Wait for a while to check if the inverter is back to normal. -Or consult us for solutions.
IE:00034	HardLimitFault	Hard Limit Fault (in Australian standard). -Wait for a while to check if the inverter is back to normal. -Or consult us for solutions.
IE:00018 IE:00019	ResidualOCP	Overcurrent Protection Fault. -Check the connections of the inverter. -Wait for a while to check if the inverter is back to normal. -Or consult us for solutions.
IE:00020	IsoFault	Isolation Fault. -Check the connections of the inverter. -Or consult us for solutions.
IE:00021	OverTempFault	Over Temperature Fault. -Check if the inverter and the ambient temperature exceeds the operating range. -Or consult us for solutions.
IE:00055	EarthFault	Earth Fault. -Check if the earth is connected properly -Or consult us for solutions.

Code	Faults	Diagnosis and solution
IE:00029	LowTempFault	Low Temperature Fault. -Check if the ambient temperature is too low. -Or consult us for solutions.
IE:00036	InternalComFault	Internal Communication Fault. -Restart the inverter to check if it is back to normal. -Update the ARM software or reburn the program. -Or consult us for solutions.
IE:00037	EepromFault	DSP EEPROM Fault. -Disconnect PV wiring and reconnect. -Or consult us for solutions.
IE:00038	RcDeviceFault	Residual Current Device Fault. -Restart the inverter. -Update the ARM software or reburn the program. -Or consult us for solutions.
IE:00041 IE:00042 IE:00043 IE:00044	PVConnDirFault	PV Direction Fault. -Check if the PV+/- sides are connected correctly. -Or consult us for solutions.
IE:00039 IE:00056	GridRelayFault	Relay Fault. -Check the grid connection. -Restart the inverter. -Or consult us for solutions.
ME:00103	Mgr EEPROM Fault	ARM EEPROM Fault. -Disconnect PV and grid, then reconnect. -Or consult us for solutions.
ME:00105	Meter Fault	Meter Fault. -Check the connection of the meter. -Check if the meter is in working order. -Or consult us for solutions.
ME:00101	PowerTypeFault	Power Type Fault. -Check the version of ARM and DSP. -Check the product SN number. -Or consult us for solutions.
ME00104	Mgr Comm Fault	Mgr InterCom Fault -Shut down photovoltaic, battery and grid, reconnect. -Or ask for help from the installer if it can not return to normal .
IE:00016	SW OCP Fault	Software Overcurrent Protection Fault. -Wait for a while to check if the inverter is back to normal. -Disconnect PV and grid, then reconnect. -Or consult us for solutions.

7.2 Routine Maintenance

Inverters do not need any maintenance or correction in most cases, but if the inverter often loses power due to overheating, this can be attributed to the following reason:

- The cooling fins on the rear of the inverter are covered by dirt.

- Clean the cooling fins with a soft dry cloth or brush if necessary.
- Only trained and authorized professional personnel who are familiar with the requirements of safety are allowed to perform servicing and maintenance work.
- Before cleaning, please wait for a few minutes to make sure the machine is cooled down and make sure the machine is shut off in case of electric shock.

Safety checks

Safety checks should be performed at least every 12 months by manufacturer's qualified person who has adequate training, knowledge, and practical experience to perform these tests. The data should be recorded in an equipment log. If the device is not functioning properly or fails any of test, the device has to be repaired. For safety check details, refer to section 2 Safety instruction and CE Directives on this manual.

Maintain periodically

During the process of using the inverter, the manage person shall examine and maintain the machine regularly. The specific operations are as follows.

- 1) Check that if the cooling fins on the rear of the inverter are covered by dirt, and the machine should be cleaned when necessary. This work shall be checked time to time.
- 2) Check that if the indicators of the inverter are in normal state, check if the display of the inverter is normal. This check should be performed at least every 6 months.
- 3) Check that if the input and output wires are damaged or aged. This check should be performed at least every 6 months.
- 4) Check whether the ground terminal and ground cable are securely connected and all terminals and ports are properly sealed every 12 months.
- 5) You should get the inverter panels cleaned and their security checked at least every 6 months.

8 Decommissioning

8.1 Dismantling the Inverter

- Turn off the AC and DC switches of the inverter system
- Wait for 5 minutes for de-energizing
- Disconnect the AC output and then the DC input, communication and other cables
- Remove the inverter from the bracket
- Remove the bracket if necessary



WARNING!

- Before dismantling the inverter, please be sure to disconnect the DC switch, and then unplug the PV and AC cables, otherwise it will lead to an electric shock hazard.
- Do not touch any inner live parts until at least 10 minutes after disconnecting the inverter from the utility grid and the PV input.

8.2 Packaging

If possible, please pack the inverter with the original packaging.

If it is no longer available, you can also use an equivalent carton that meets the following requirements.

- Suitable for loads more than 30 kg.
- With handle.
- Can be fully closed.

8.3 Storage and Transportation

Store the inverter in dry place where ambient temperatures are always between $-30\text{ }^{\circ}\text{C} \sim +70\text{ }^{\circ}\text{C}$. Take care of the inverter during the storage and transportation.

8.4 Disposal of the inverter

If the service life of our inverter expires, dispose of it according to the local disposal rules for electrical equipment waste.

When the inverter or other related components need to be disposed. Have it carried out according to local waste handling regulations. Please be sure to deliver wasted inverters and packing materials to certain site, which can assist relevant department to dispose and recycle.

9 Disclaimer

This limited warranty applies to products sold after date of 1st Jan 2022, and sold through our company or authorized resellers. The defective parts or units replaced under a warranty claim become our properties, and must be returned to us or Authorized Cooperated Partners (distributors) for inspection with the original or equivalent packaging. The product is not covered by warranty in the following cases:

- A.The product is out of the warranty period;
- B.Product failure is not reported to us within one month of appearance;
- C.Failed to comply with our installation manual or maintenance instructions for the inverter or accessory;
- D.Failed to comply with the safety rules and regulations in respect of the inverter or accessory;
- E.The inverter or accessory is damaged during transportation but the claimant has signed the delivery receipt (which requests the claimant to double check the outside & inside of the package and take pictures as evidence before signing the delivery receipt);
- F.The replaced products have not been returned to us or cooperated partners (distributors) within 30 days;
- G.The defect is caused by improper usage of the product or failure to comply with the usage of the product for purposes other than those for which the product was designed or intended;
- H.The product is moved for any reason after it has been installed (regardless of whether it has been reinstalled subsequently or moved back to the same location) unless it is reinstalled at the same address by a qualified installer who has provided a test report to our company.
- I.The damage or defect is caused by lightning, flood, fire, power surge, corrosion, pest damage, actions of a third-party, or any other force majeure factors;
- J.The damage or defect is caused by embedded or external software or

hardware (eg. the devices to control the inverters or the devices to control battery charging or discharging) from third parties without authorization (agreement in writing) from our company;

K.The product is modified or altered (including the cases in which the product series number or product label is altered, removed, or defaced);

L.Flaws (eg. any external scratch or stain, or nature material wearing which does not represent a defect) that do not adversely affect the proper functioning of the inverter or accessory

M.Normal wear or tear;

N.Travel and subsistence expenses as well as on-site installation, modification and normal maintenance costs;

O.Duties, import/export fees or costs and other general administrative costs;

The substitute inverter or accessory with technical improvement may not be entirely compatible with the remaining components of the photovoltaic system. The costs incurred as a consequence will not be covered by the warranty or extended warranty.

Furthermore, all other costs including but not limited to compensation from direct or indirect damages arising from the defective device or other facilities of the PV system, or loss of power generated during the product downtime are not covered by this warranty. In any other case, whether in contract, tort, or otherwise, the maximum compensation for customer losses caused by its faults shall not exceed the amount paid by the customer for the purchase of the equipment.

Warranty Registration Form



For Customer (Compulsory)

Name Country

Phone Number Email

Address

State Zip Code

Product Serial Number

Date of Commissioning

Installation Company Name

Installer Name Electrician License No.

For Installer

Module (If Any)

Module Brand

Module Size(W)

Number of String Number of Panel Per String

Battery (If Any)

Battery Type

Brand

Number of Battery Attached

Date of Delivery Signature

Please visit our warranty website: <https://www.solaxcloud.com/#/warranty> to complete the online warranty registration or use your mobile phone to scan the QR code to register.

For more detailed warranty terms, please visit SolaX official website: www.solaxpower.com to check it.





**PLEASE REGISTER THE WARRANTY IMMEDIATELY AFTER INSTALLATION!
GET YOUR WARRANTY CERTIFICATE FROM SOLAX!
KEEP YOUR INVERTER ONLINE & WIN SOLAX POINTS!**

1

Open your camera app and point your device at the QR code



2

Wait for the camera to recognize the QR code



3

Click banner or notification when it appears on the screen



4

Warranty registration page will be loaded automatically

